

CENTROTECNICA
stress to ensure

Suitable for all shakers and chosen as original equipment by IMV Corp.

the Slip Tables

THE BEST SOLUTION TO VIBRATE HORIZONTALLY

THE SLIP TABLE, A PRECIOUS COMPLEMENT FOR THE SHAKER

The slip tables for shakers allow a sample to be tested along horizontal axes without changing its orientation with respect to gravity.
The need to maintain the orientation of the sample throughout the testing program is often a must.

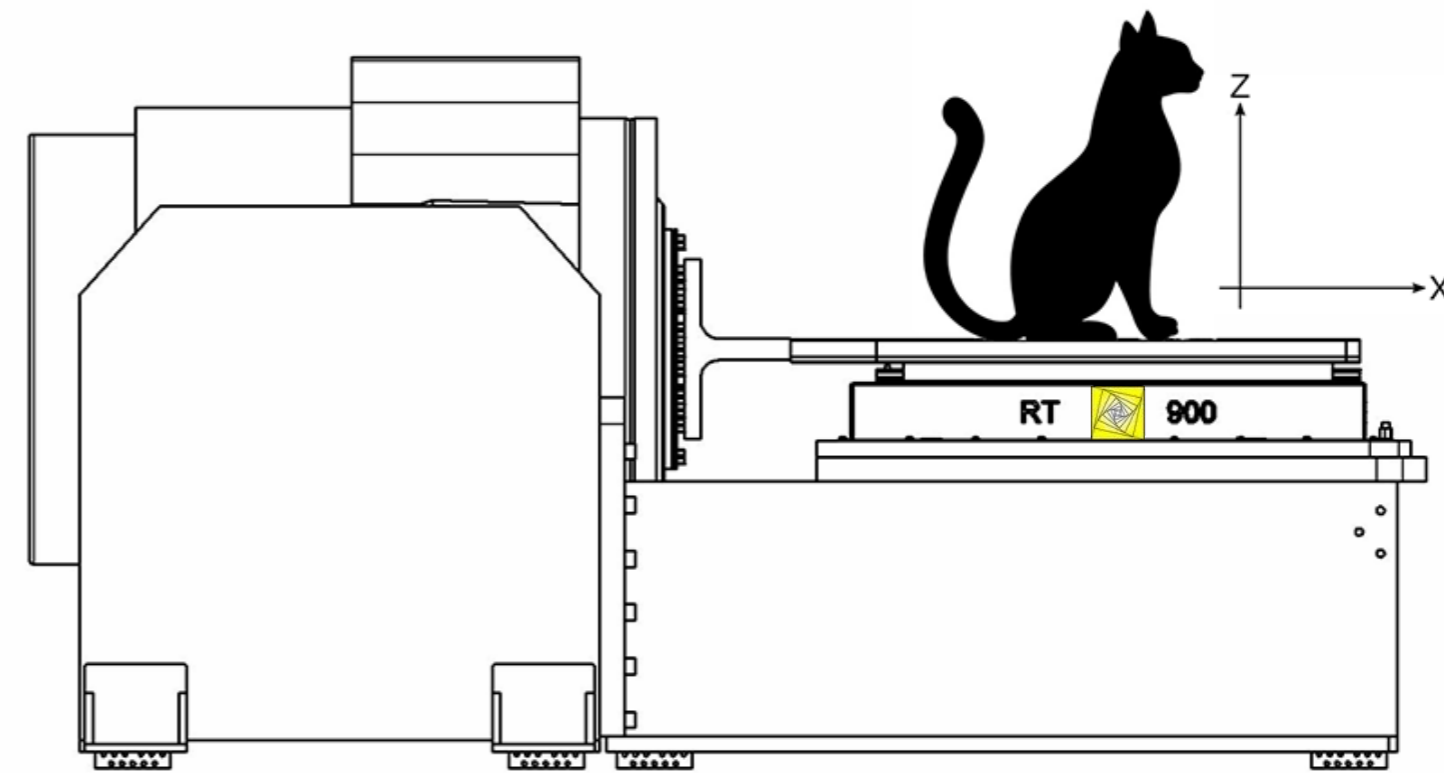
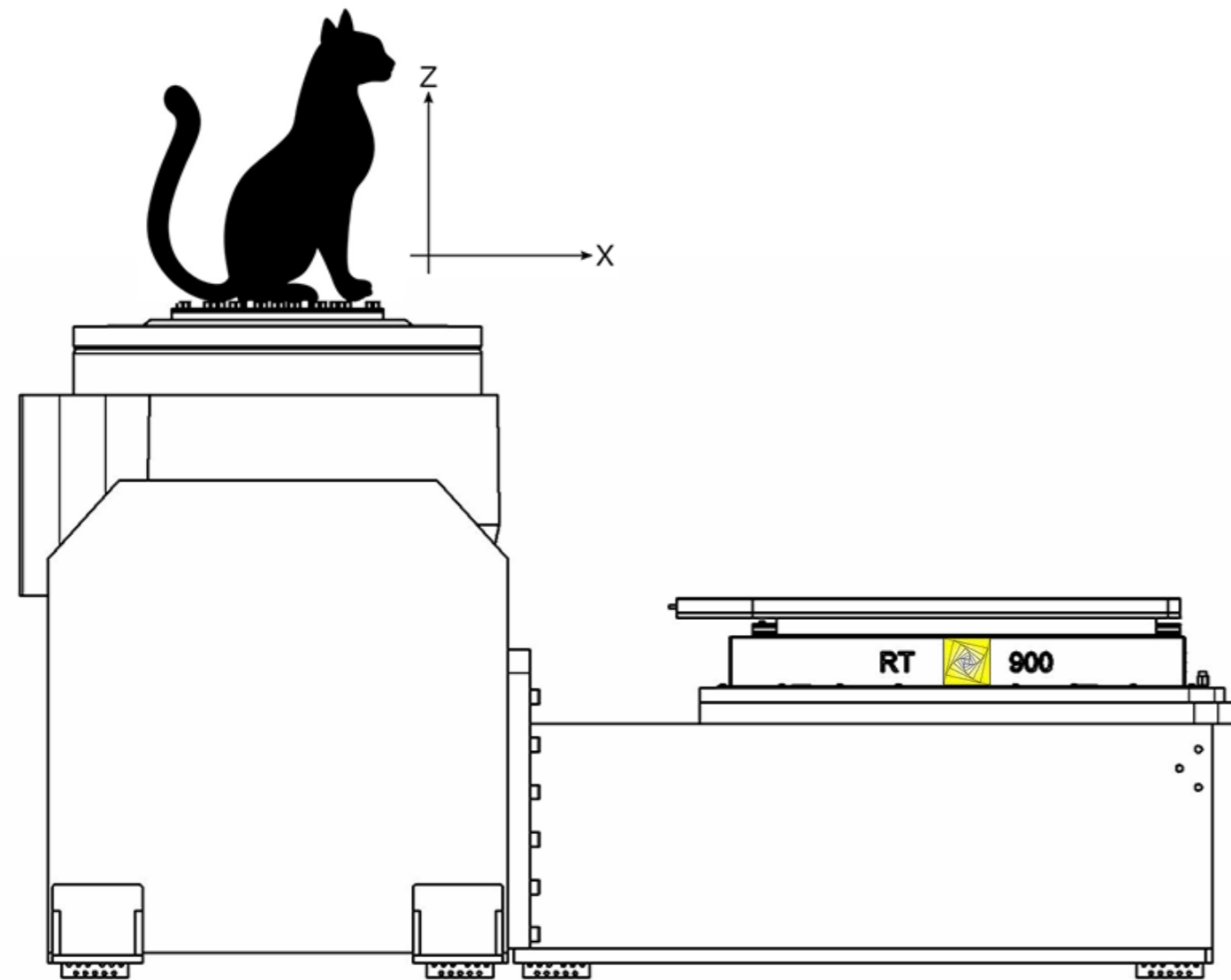

VST AND RT: TWO TECHNOLOGIES TO MEET ALL REQUIREMENTS

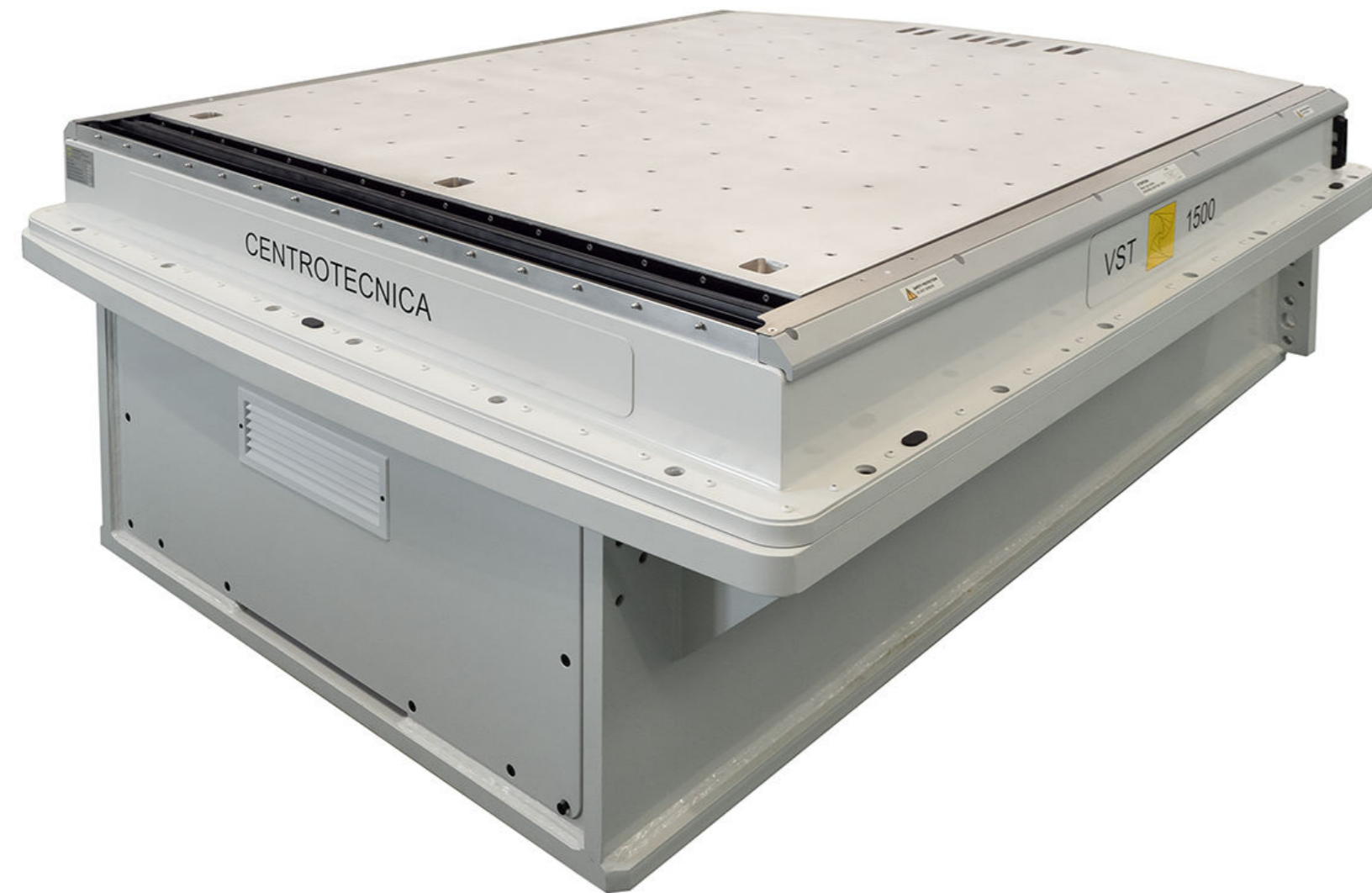

VST: hydrostatically supported product, it uses vacuum force as the drive system. It offers very high performance due to exclusive, patent-protected technology. The benefits offered by this product are most noticeable with large slip tables.

The VST are the only slip tables in the world with a safety system that prevents damage in case of vacuum loss.

RT: the flagship of the company's production and an innovative concept product: the table moves on bearings that run along rails.

It is characterized by the very high possibility of customization, which makes it possible to approach all kinds of tests with the most efficient solution for the vibrating system.

The RT are also highly appreciated for its high reliability and minimal maintenance required.

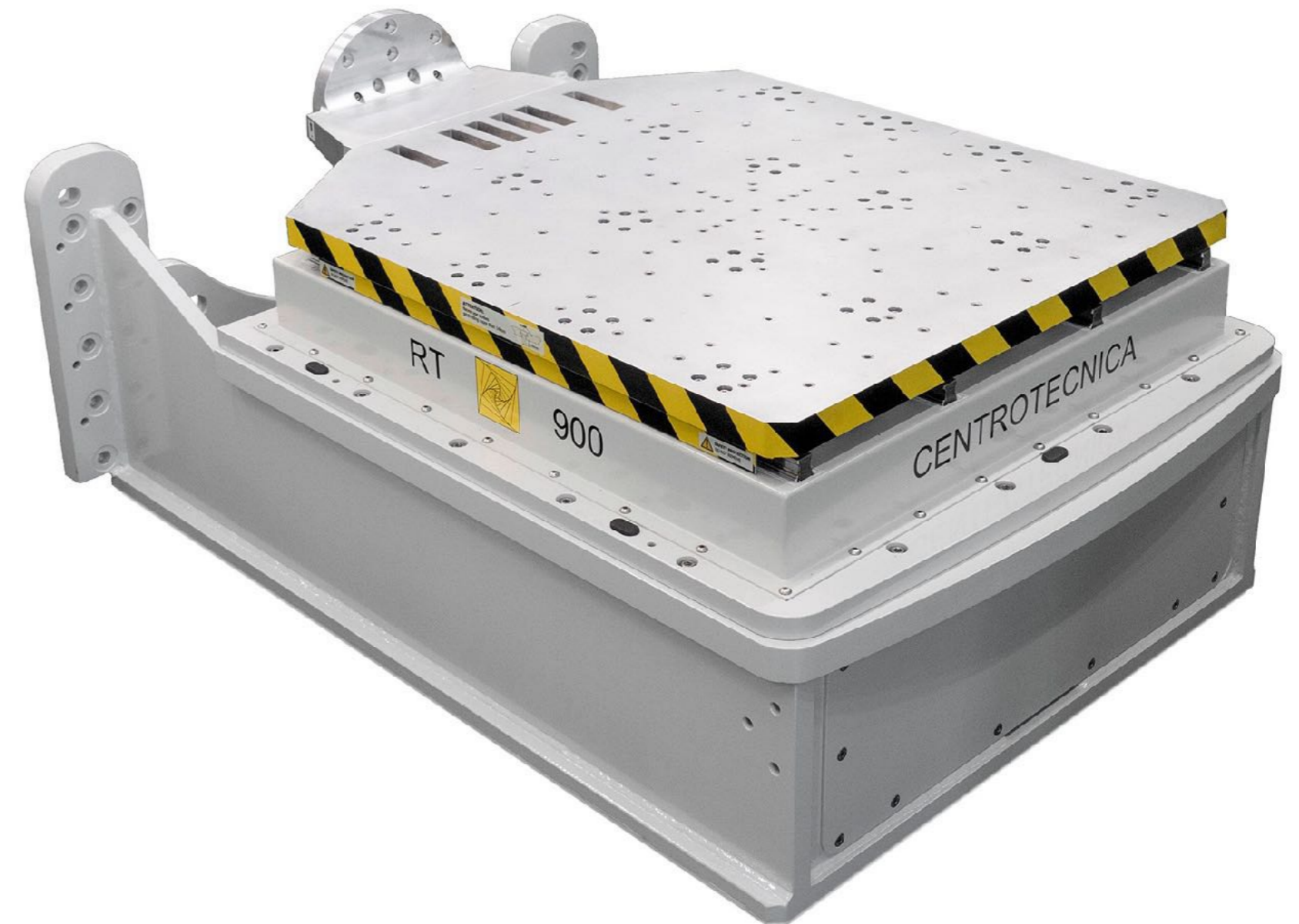

VST: ACTIVATED BY BALANCING OIL PRESSURE AND VACUUM FORCE

MAIN FEATURES:

- Modular design
- High strength and reliability
- High damping ratio
- The table rests uniformly on the entire surface
- High vacuum force ensures high moments
- Interlock on over pitch moment
- No bearing mass in addition to the table mass
- Long stroke: 160 mm
- Minimum alignment
- Suitable for heavy samples
- ECO – plc controlled pressure and vacuum
- Log file of the parameters for maintenance

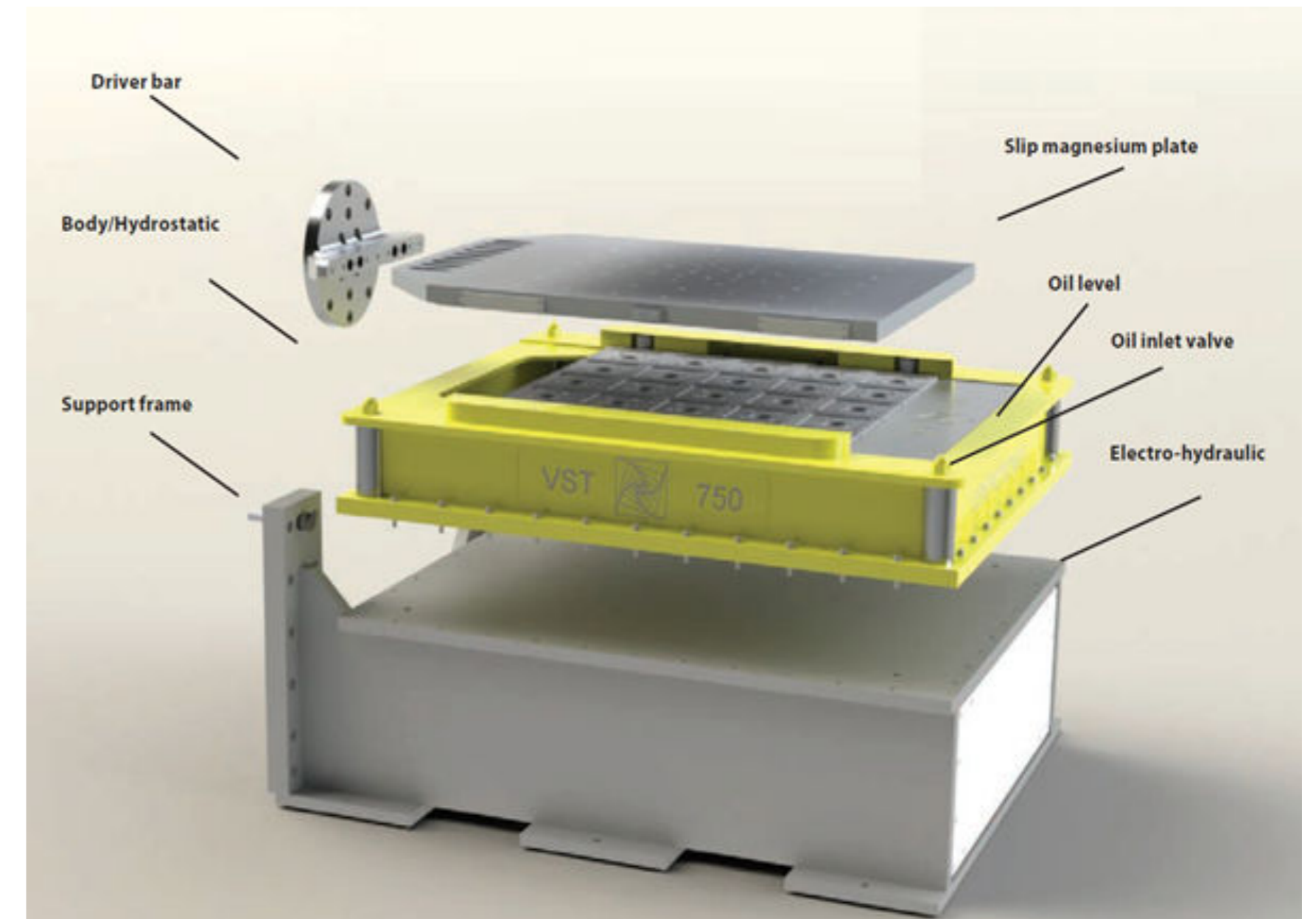

VST: DESIGNED IN EVERY DETAIL TO PROVIDE MAXIMUM PERFORMANCE

Vacuum and oil recirculation are ensured by a pump patented by CENTROTECNICA.

The table base is machined to extremely high surface treatment tolerances and ensures frictionlessness and durability.



The slip tables are interchangeable with the same base.

In this way the optimum solution for the most efficient energy consumption can always be achieved.

The optional front cover ensures that circulating oil does not come into contact with the sample. In some areas

(such as aerospace), safeguarding the cleanliness of the sample is essential.



VST: SPECIAL OPTIONS FOR MAXIMUM VERSATILITY

The spacer slip table is dedicated to couplings between slip tables and climate chambers:

- It allows a perfectly centred positioning between slip table and climatic chamber.
- It enables the complete lowering of the chamber (unlike elongated driver bars, whose ribs create interference).

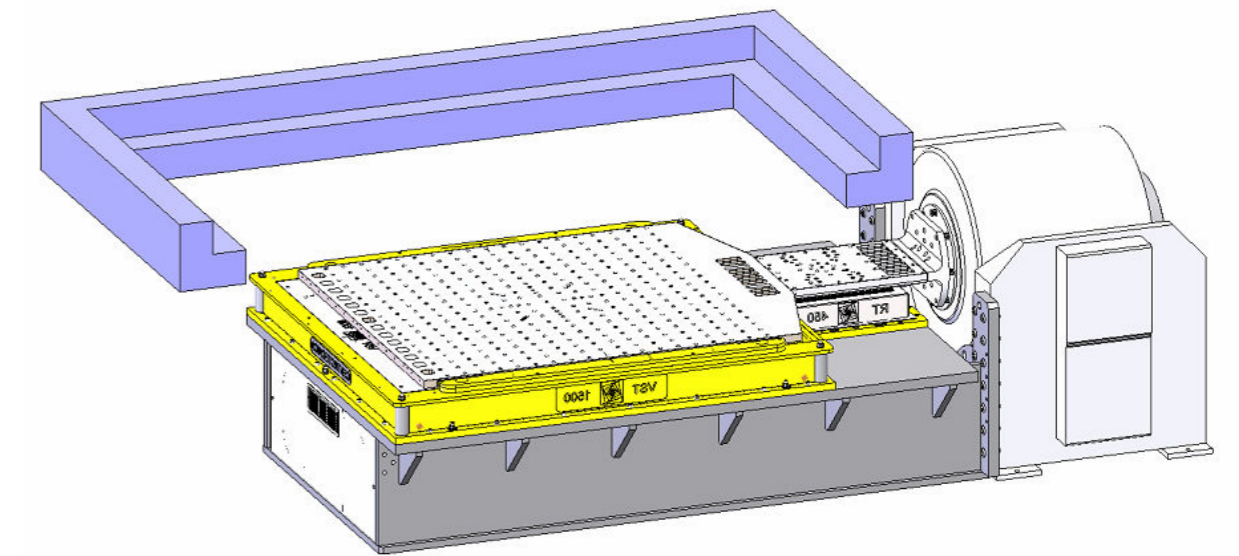

The slip table with double driver bar allows for in-line working of 2 opposing shakers.

This type of configuration is necessary when the force of a single shaker is not sufficient to replicate the test profile.

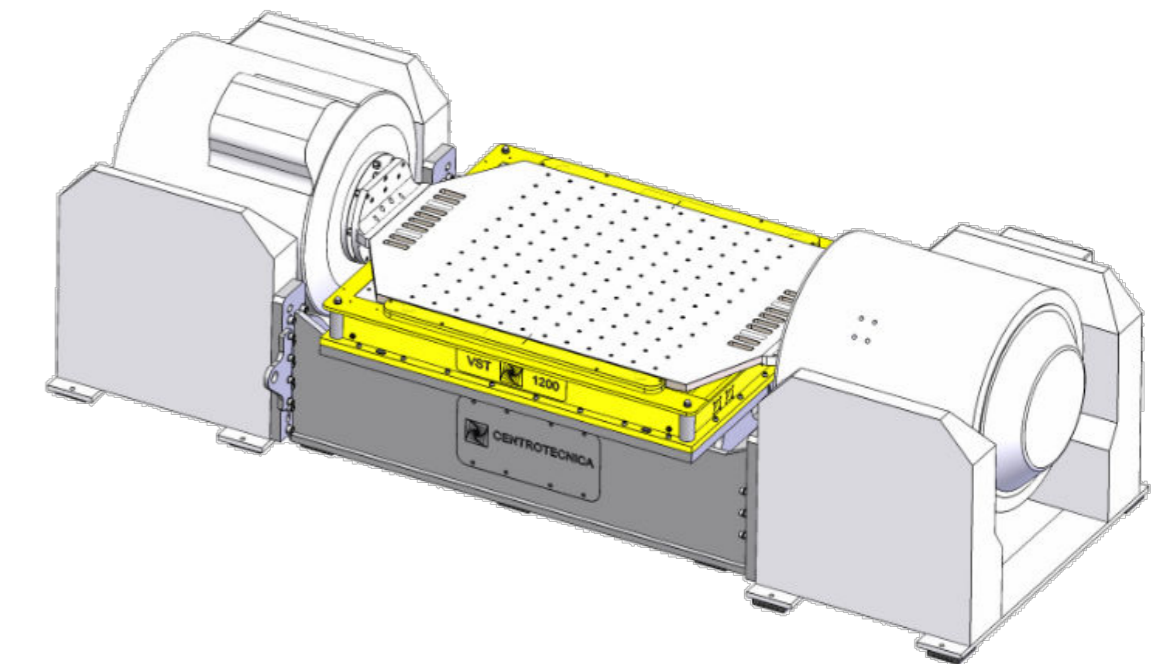

VST: SIZES AND TECHNICAL CHARACTERISTICS

| MODEL | Table size (mm) | Table weight* (kg) | Max displacement (mm) | Max payloads (kg) | Usable frequency (Hz) | First resonance (Hz) | Overturning moments (kNm) | | | |
|----------|-----------------|--------------------|-----------------------|-------------------|-----------------------|----------------------|---------------------------|-------|----------------|--------------|
| | | | | | | | Pitch | Roll | Yaw continuous | Yaw ultimate |
| VST 600 | 600 x 600 | 35 | 160 | 640 | 2.000 | 1.250 | 7.7 | 7.7 | 2.8 | 23.4 |
| VST 750 | 750 x 750 | 50 | 160 | 1.000 | 2.000 | 1.050 | 15.0 | 15.0 | 3.7 | 31.2 |
| VST 900 | 900 x 900 | 67 | 160 | 1.450 | 2.000 | 950 | 25.9 | 25.9 | 4.7 | 39 |
| VST 1050 | 1050 x 1050 | 88 | 160 | 1.950 | 2.000 | 830 | 41.2 | 41.2 | 5.6 | 46.8 |
| VST 1200 | 1200 x 1200 | 111 | 160 | 2.550 | 2.000 | 730 | 61.4 | 61.4 | 6.5 | 54.6 |
| VST 1350 | 1350 x 1350 | 150 | 160 | 3.200 | 2.000 | 660 | 87.5 | 87.5 | 7.4 | 62.4 |
| VST 1500 | 1500 x 1500 | 167 | 160 | 4.000 | 2.000 | 600 | 120 | 120 | 8.4 | 70.2 |
| VST 1800 | 1800 x 1800 | 243 | 160 | 5.650 | 2.000 | 550 | 207.4 | 207.4 | 10.2 | 85.8 |

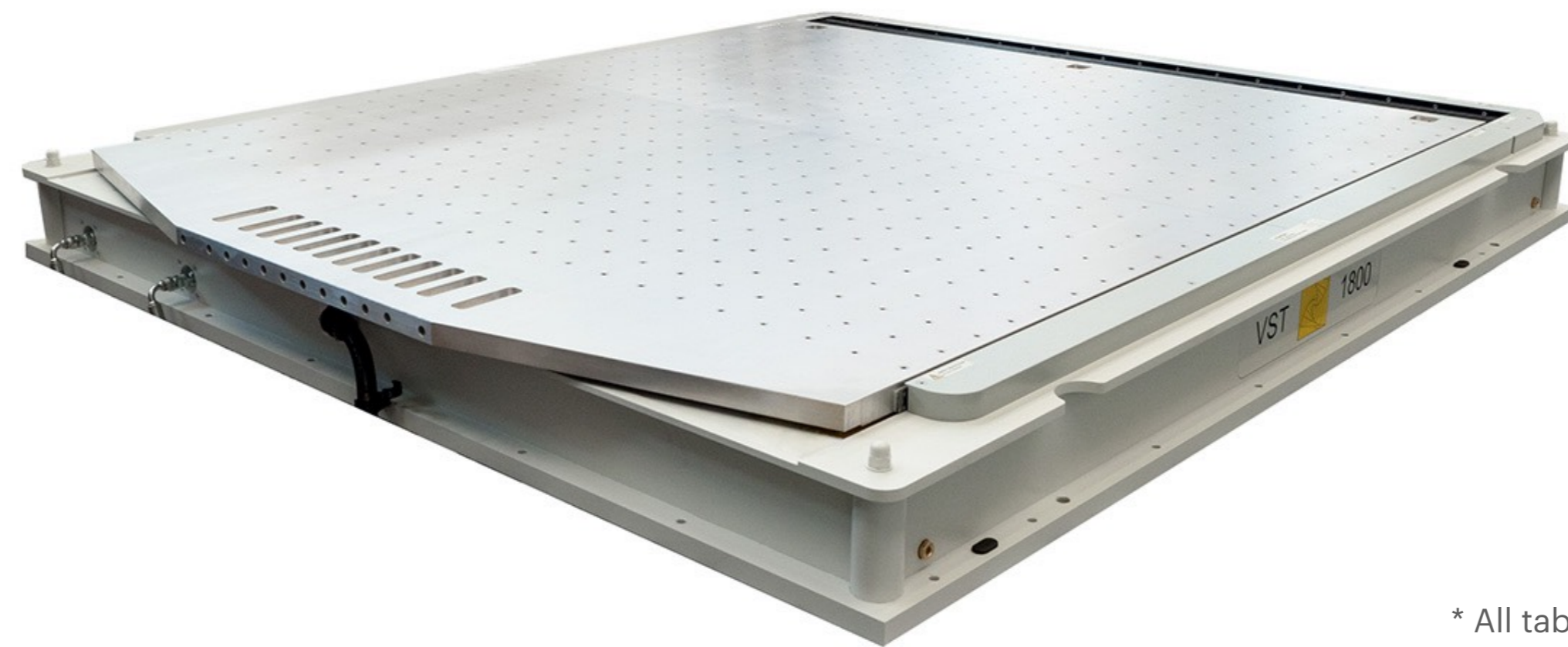
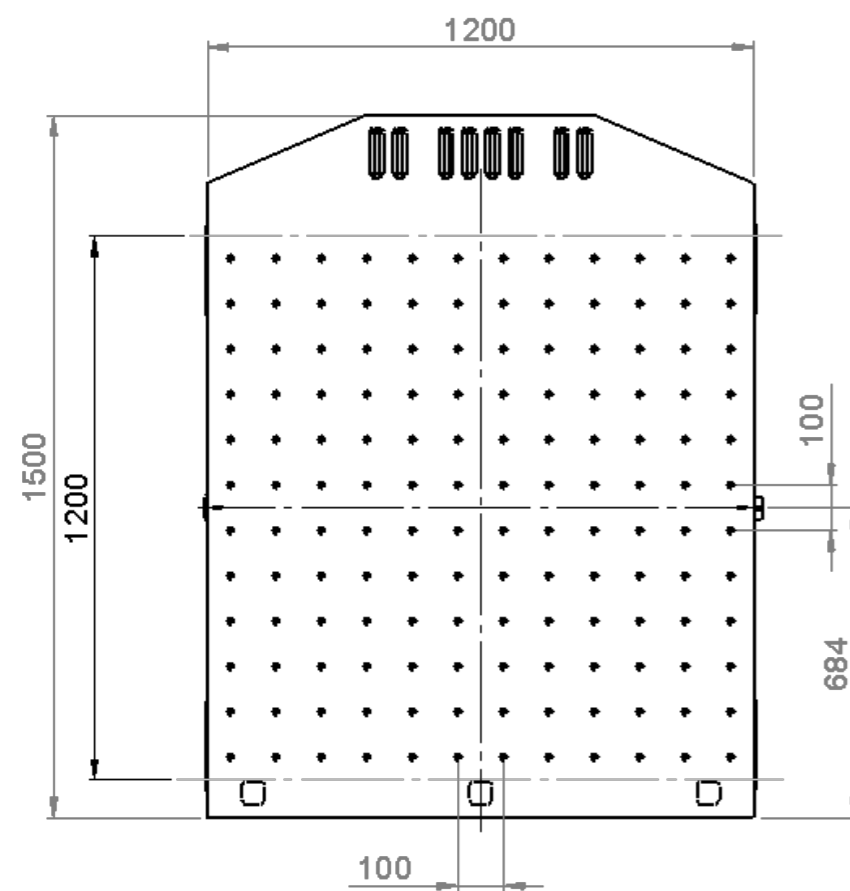

* All tables are made of magnesium.

RT: THE SIMPLICITY AND EFFECTIVENESS OF SLIDING ALONG RAILS

MAIN FEATURES:

- Purely mechanical structure
- No oil, no electric components, no compressed air
- High robustness and resistance to bending
- High damping ratio
- Reduced moving mass
- Quickly interchangeable table
- Easy alignment
- Heavy loads improve performance
- Ideal for coupling to climatic chambers
- The only ones with a system to allow thermal expansion without deformation
- Very simple maintenance: cleaning the skids

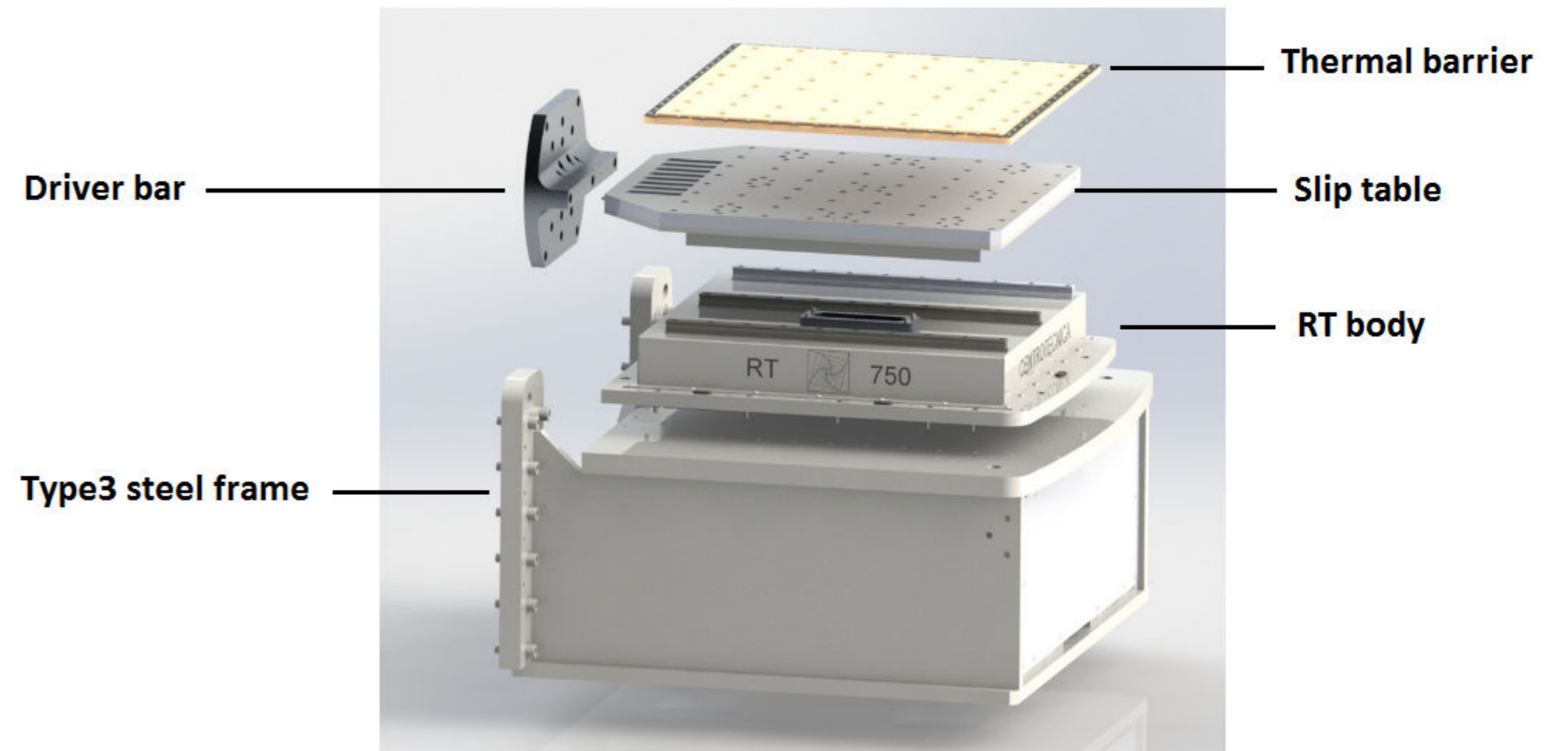

RT: DESIGNED IN EVERY DETAIL TO MINIMISE MOVING MASSES

The RT slip tables are interchangeable, and as there is only a mechanical connection between the base and the table, operation is particularly quick and easy.

There are no other systems that allow this level of versatility of configuration.

The use of a smaller slip table, when possible, is highly recommended to optimize power consumption, shaker wear and higher accelerations.

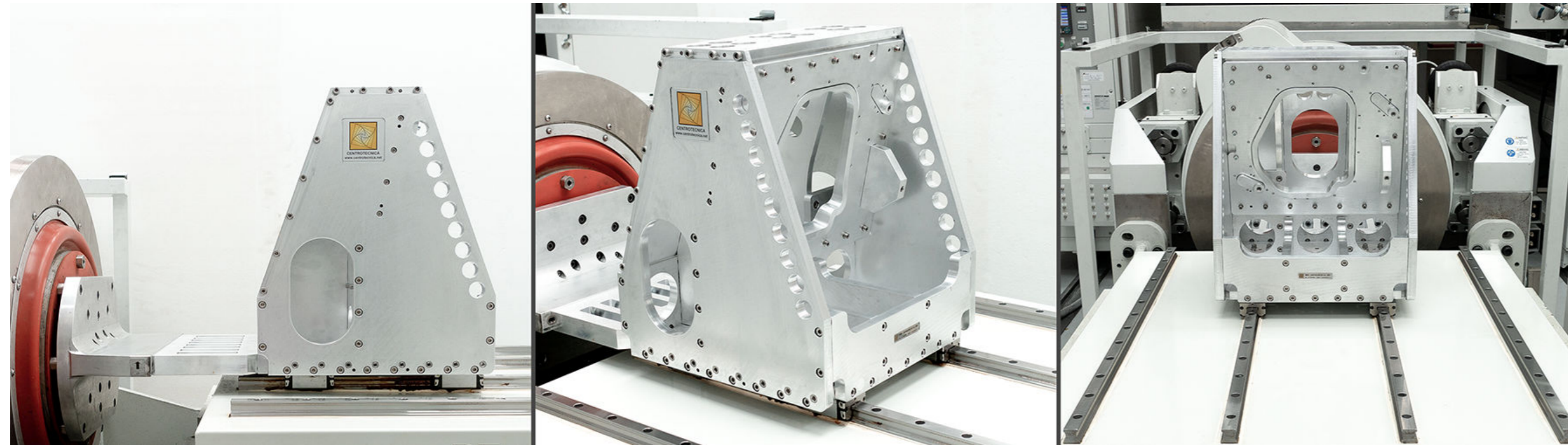
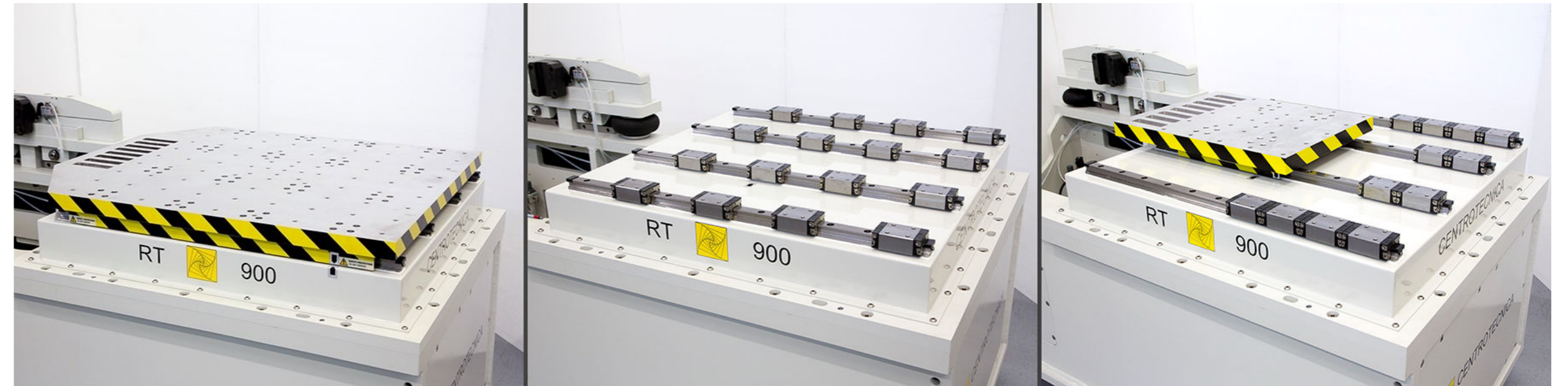

CENTROTECNICA has taken the concept of weight saving to the extreme by developing the RT fixture solution: fixtures that mount directly onto the RT slip table rails, eliminating the need for a table.

This very interesting and innovative system is currently only possible with the base of our RTs.

We can adapt almost any fixture for this use.

RT: SIZES AND TECHNICAL DATA

| MODEL | Table size (mm) | Table weight (kg) | | Max displacement (mm) | Max payloads (ton)* | Usable frequency (Hz) | First resonance (Hz)** | Overturning moments (kNm) | | | | | | | | |
|---------|-----------------|-------------------|-----------|-----------------------|---------------------|-----------------------|------------------------|---------------------------|-------|----------|----------|-------|----------|----------|-------|----------|
| | | Aluminium | Magnesium | | | | | Pitch* | | | Roll* | | | Yaw* | | |
| | | | | | | | | Long run | Shock | Ultimate | Long run | Shock | Ultimate | Long run | Shock | Ultimate |
| RT 450 | 450 x 450 | 30 | 23 | 160 | 3.3 | 2.000 | 1.400 | 6.3 | 12.6 | 15.75 | 9.7 | 19.4 | 24.5 | 6.3 | 12.6 | 15.75 |
| RT 600 | 600 x 600 | 50 | 40 | 160 | 7.4 | 2.000 | 1.250 | 16.9 | 33.8 | 42.25 | 24.8 | 49.6 | 62 | 16.9 | 33.8 | 42.25 |
| RT 750 | 750 x 750 | 68 | 53 | 160 | 7.4 | 2.000 | 1.050 | 24.3 | 48.6 | 60.75 | 29.7 | 59.4 | 74.25 | 24.3 | 48.6 | 60.75 |
| RT 900 | 900 x 900 | 96 | 75 | 160 | 13.2 | 2.000 | 950 | 56.4 | 112.8 | 141 | 70.3 | 140.6 | 175.75 | 56.4 | 112.8 | 141 |
| RT 1050 | 1050 x 1050 | 125 | 98 | 160 | 13.2 | 2.000 | 830 | 69.6 | 139.2 | 174 | 71.6 | 143.2 | 179 | 69.6 | 139.2 | 174 |
| RT 1200 | 1200 x 1200 | 160 | 125 | 160 | 13.2 | 2.000 | 750 | 82.8 | 165.6 | 207 | 89.9 | 179.8 | 224.75 | 82.8 | 165.6 | 207 |
| RT 1500 | 1500 x 1500 | 230 | 175 | 160 | 16.5 | 2.000 | 700 | 122.9 | 245.8 | 307.25 | 144.1 | 288.2 | 360.25 | 122.9 | 245.8 | 307.25 |
| RT 2000 | 2000x 2000 | 370 | 282 | 160 | 20.7 | 2.000*** | 430 | 215.6 | 431.2 | 539 | 218.6 | 237.2 | 546.5 | 215.6 | 431.2 | 539 |



The driver bars shown in the picture are not included in the technical data of the table above.

* the values refer to an equally distributed load. For different conditions, values can be provided on request.

** the correct value can be influenced by the shaker and the type of coupling.

*** The frequency range can be achieved with a suitable multipoint control strategy suggested by CENTROTECNICA.

RT-SP: EVOLUTION OF RT SLIP TABLES DEDICATED TO SPACE TESTING



RT 2000 SP in use at the clean room
at CENTROTECNICA's space testing laboratory.

¹ the custom fixture, the bearings configuration and the shaped table can be provided by CENTROTECNICA.

RT series slip tables are equipped with a fully mechanical, **OIL-FREE** guiding system, a feature that eliminates the risk of DUT contamination. This feature is particularly appreciated by space-sector customers testing in clean room.

The main innovation of **RT-SPs** consists in the possibility to customize the number and the location of guide bearings¹. This flexibility allows the bearings to be placed directly at the load points, optimizing the support and reducing the fixture complexity. This innovative approach allows to configure the bearings position under the load areas, instead of the standard approach where the fixture is to be designed to spread the load up to the fixed position of the bearings.

The possibility to customize the bearing configuration and use a simplified and lightened fixture¹ results in a substantial reduction of the moving mass. An additional benefit is the possibility to remove the RT table and design a tailor made fixture, mounted directly on the bearings.

Another plus provided by the **RT-SP** type slip tables is the chance to easily integrate the bearings in the FEM analysis calculations of the entire test structure, including their positions and stiffness. This makes it possible to accurately simulate the behavior of the DUT under the test conditions.

A case study is to be seen at page 6: the weight saved thanks to the targeted support, the shaped table, and the simplified fixture allowed us to perform a "sine burst" test using a 74 kN force shaker. A test that had previously failed at a laboratory equipped with a 120 kN shaker and a standard slip table, demonstrating the effectiveness of the **RT-SP** solution.

THE **RT-SP** SERIES COMPARED WITH THE **RT** - BEARINGS DISTRIBUTION

The **CUSTOMIZATION** of the bearing distribution scheme, in accordance with the mass distribution and the geometry of the test setup, is more accurate due to the presence of a higher number of bearing guides.

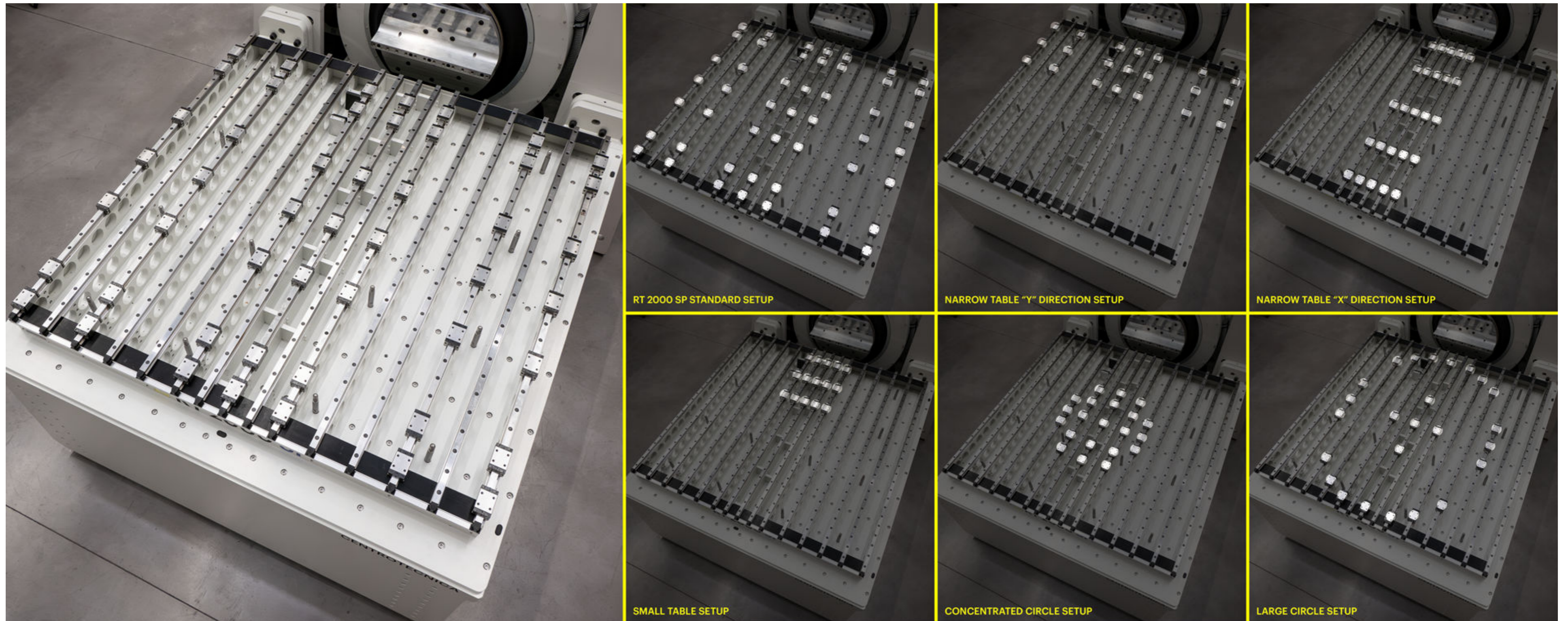

RT: DEDICATED SOLUTIONS AND ACCESSORIES THAT MAKE THEM UNIQUE

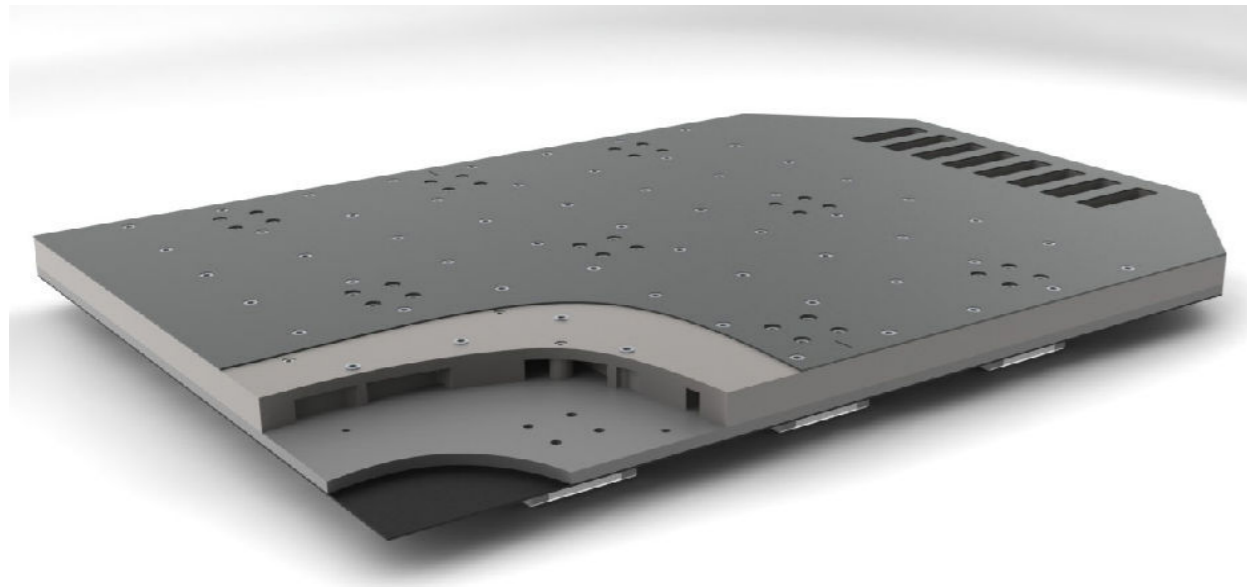

RT slip tables can resist bending better than any other slip table.

They are equipped with a special system to allow thermal expansion of the table while limiting bending.

This makes RTs particularly suitable for climatic testing.

The unique multilayer structure of the RT table also makes it particularly light and with high damping, compensating for the absence of oil.



Direct Coupling Solutions: quick coupling system between climate chamber and slip table to take full advantage of the flexibility of slip tables (not just RTs).

Minimises human work time by facilitating configuration horizontal/vertical switching for combined tests.

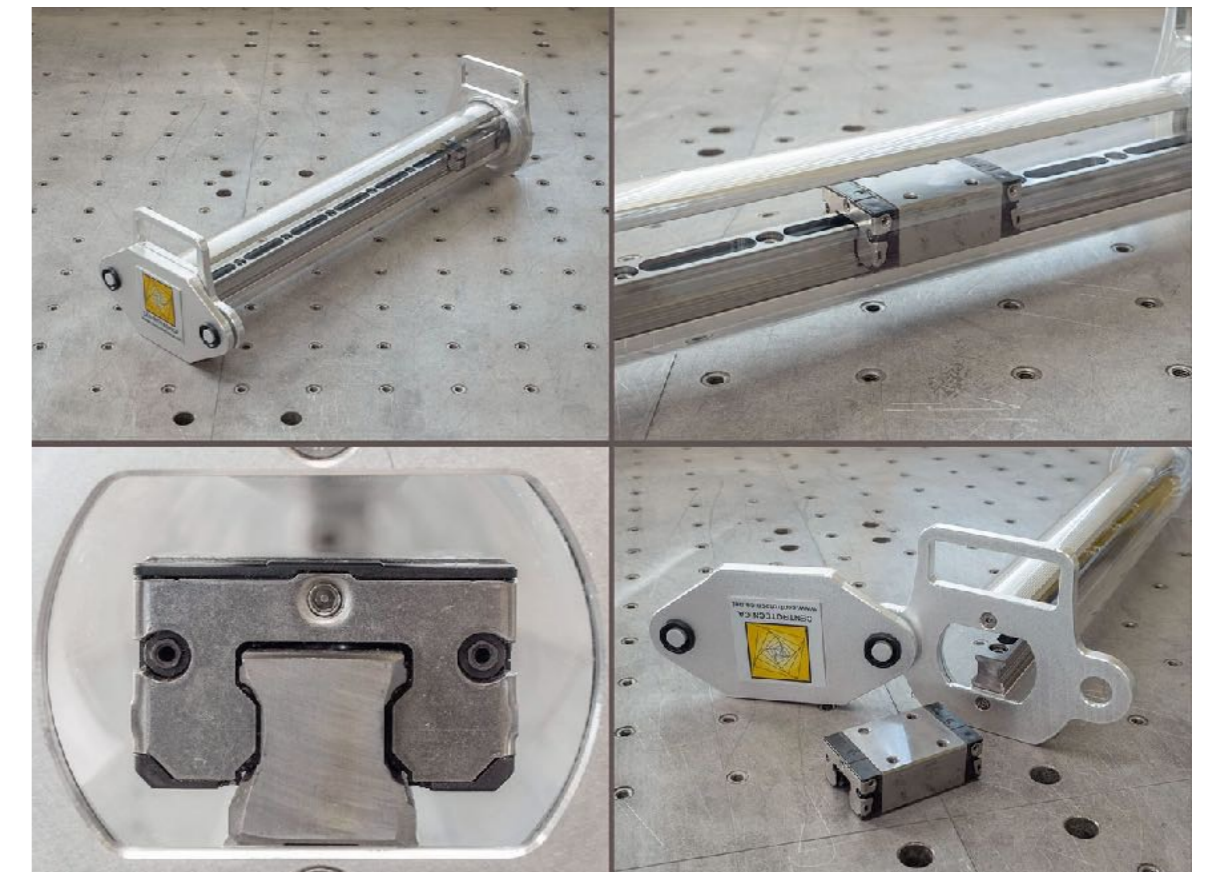

CT-SPP: accessory intended for maintenance (limited to cleaning the runners) of RT type slip tables.

Once again, a unique product on the market, simple and effective, it allows the cleaning of a single skid in less than a minute.

KRT: ENHANCING MODULARITY AND EFFICIENCY

KRT modular tables are another innovation from CENTROTECNICA.

They make it possible to **modify the surface of the slip table as quickly and easily as possible**, adapting it to the shape and size of the sample to be tested.

The advantages in reducing the moving masses are objective:

- reduce energy consumption
- reduce shaker wear and tear
- optimise shaker performance

In addition to this, the KRTs confirm all the points in favour of the RTs.

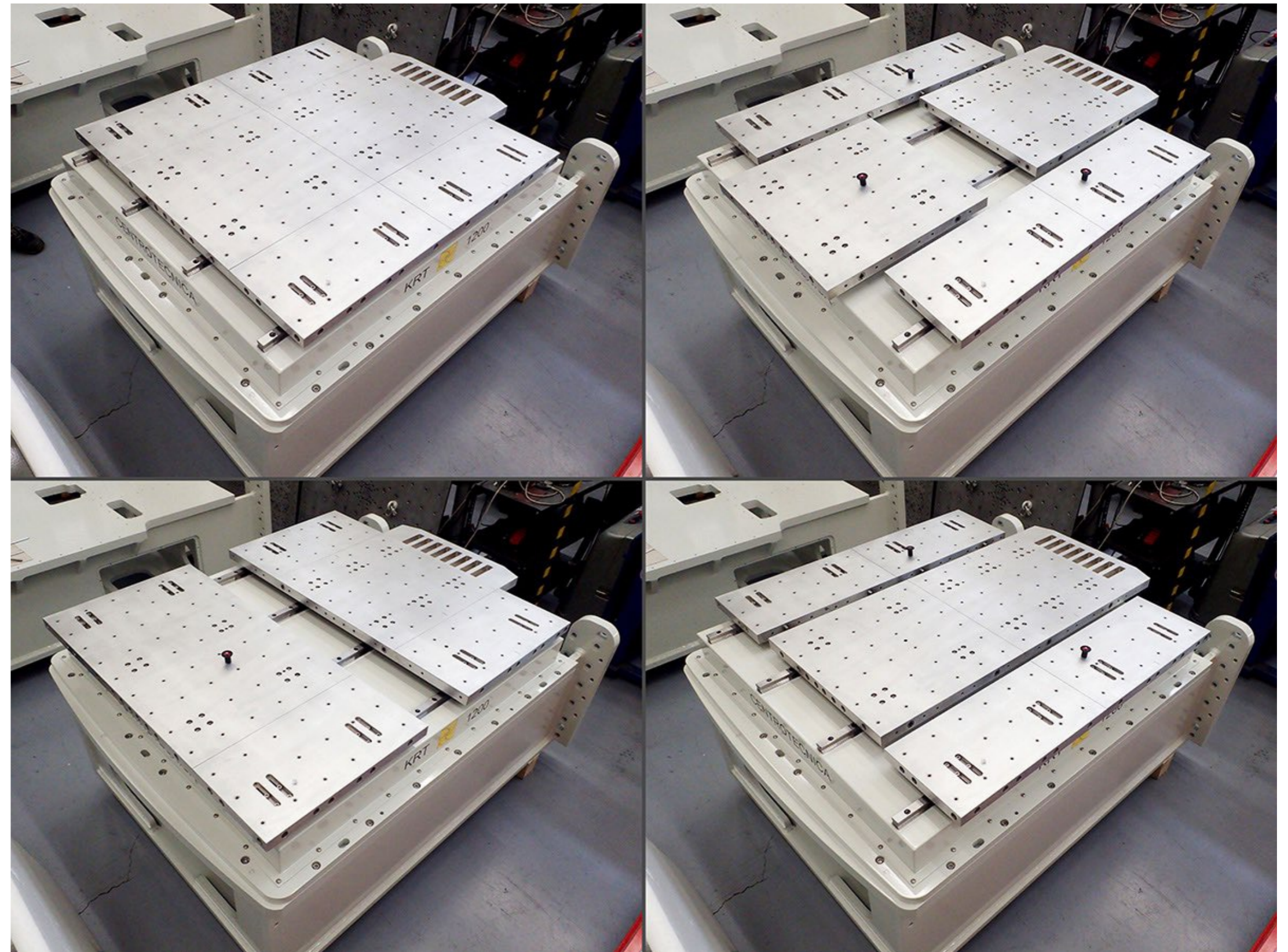

SPECIAL PRODUCTS (NOT IN THE CATALOGUE) ON REQUEST

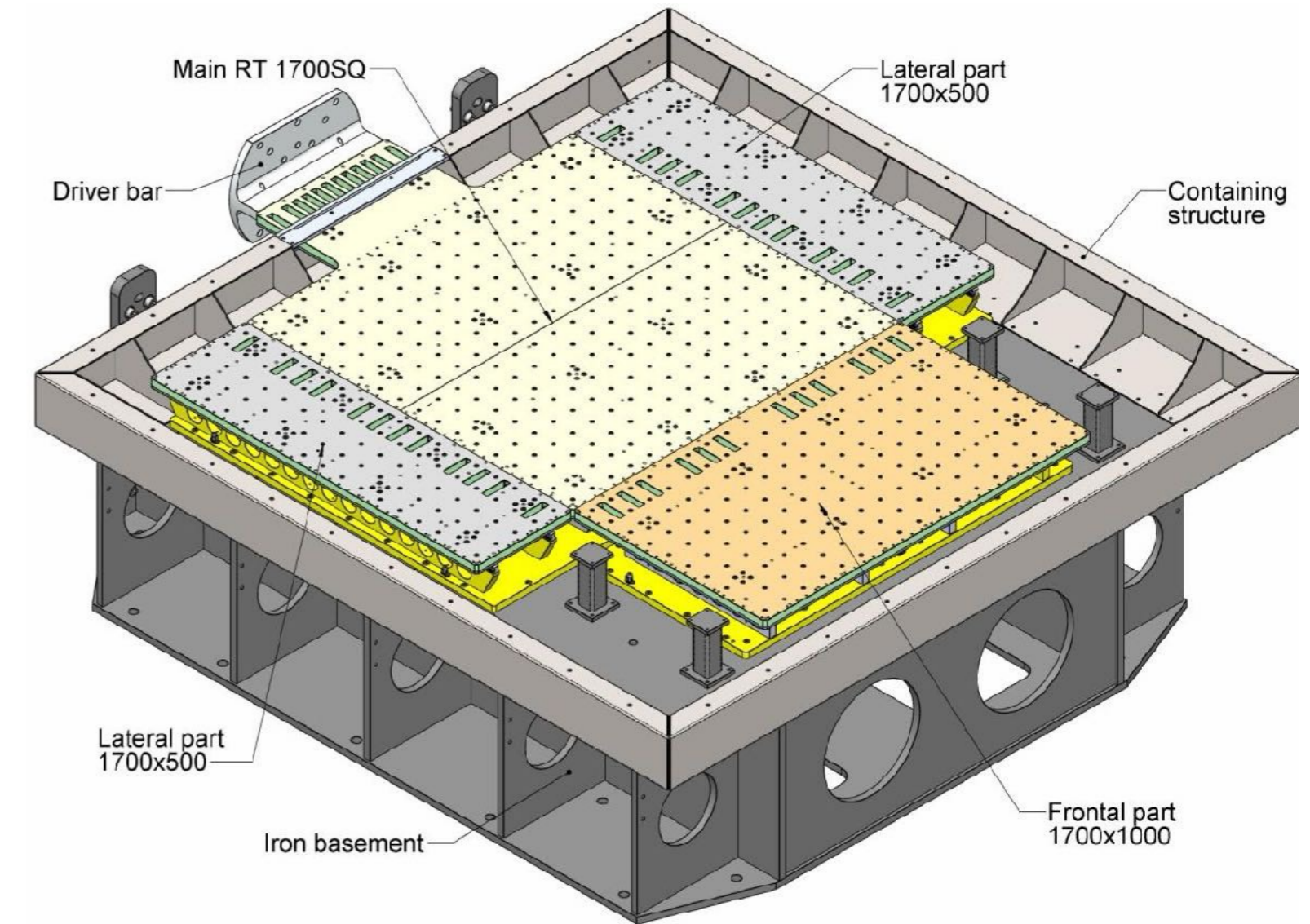

Our design department will consider any request to meet specific requirements for products not in the catalogue.

In the example above: a large KRT slip table realized on specific request for combined climate + vibration battery testing, compared with a standard RT 1050 slip table.

VERY USEFUL ACCESSORIES FOR SLIP TABLES FROM ANY MANUFACTURER

THERMAL BARRIER:

Thermal barriers are very important and highly recommended accessories in combined climate + vibration systems that offer a double advantage:

Ensure that the sample is properly insulated from the heat produced by the shaker.

Safeguard the vibrating system from the large temperature variations that occur in the climate chamber.

We produce thermal barriers in all shapes and sizes, for coupling to any head expander or slip table (also KRT type), specific for battery testing or with water drainage system.

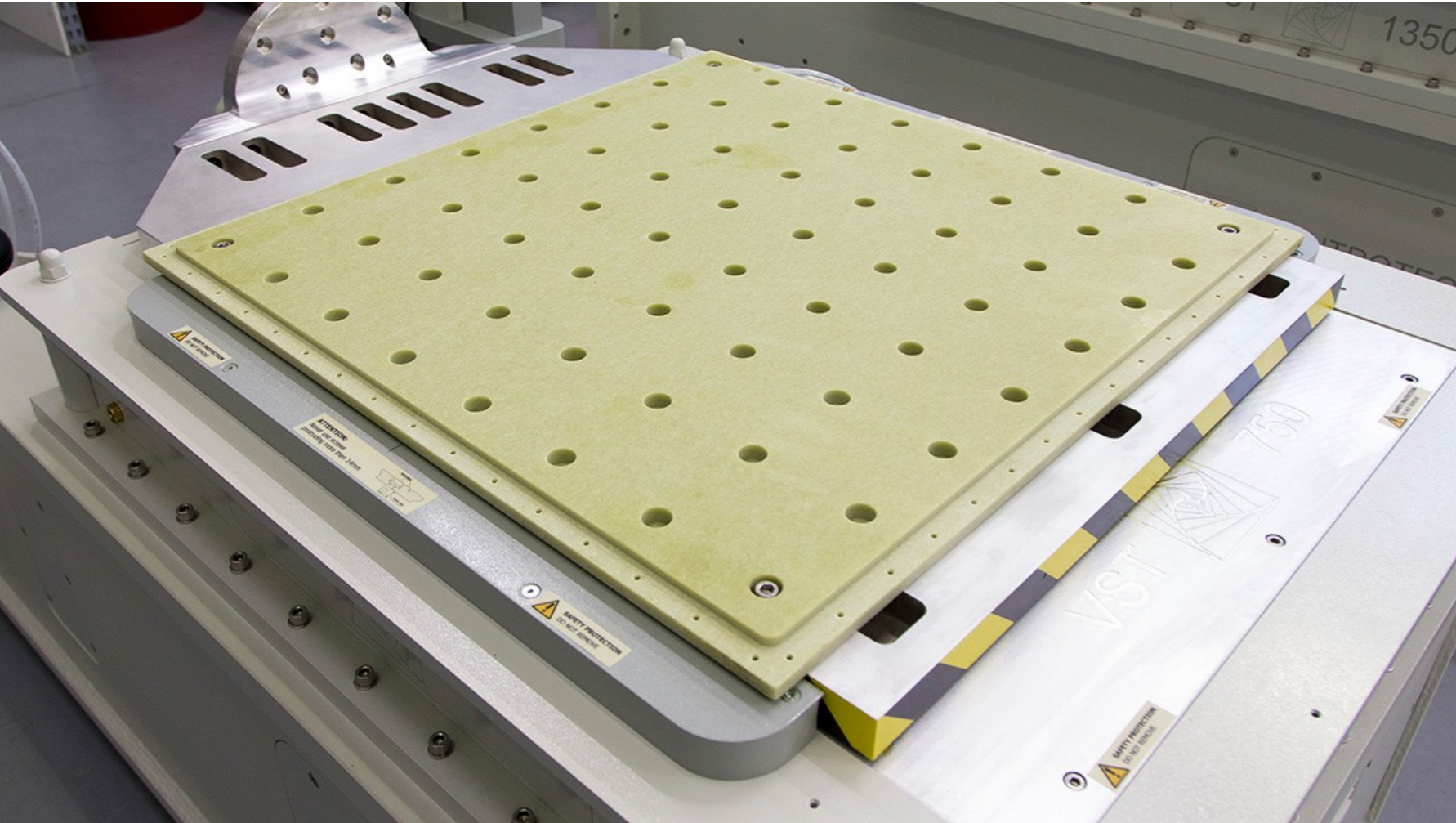

INSTANT CLAMP:

It is a revolutionary and patented system to achieve fastening between fixture and slip table or shaker or head expander assembly, in ultra-fast time.

The Instant Clamp ensures a fastening equivalent to that achieved with screws and saves an average of 95% of the time spent fixing the fixture or changing the axis to be tested..

In addition to this, it allows the design of simpler and lighter fixtures with an additional economic advantage.

It can operate in climatic chambers in a temperature range of -40°C / +140°C.



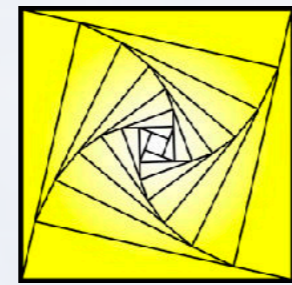

CENTROTECNICA

stress to ensure

REFERRING LINKS

[slip tables](#)

[slip tables RT-SP](#)

[Instant Clamp](#)

[thermal barriers](#)

[fixture RT](#)

[CT-SPP](#)

[design department](#)

[production department](#)

CENTROTECNICA provides installation, support, service and maintenance for all slip tables delivered worldwide. These services are provided through its network of distributors or directly.

For info or RFQs, pls contact us at mail: sales@ctecnica.it - phone: +39(0)255305888

Centrotecnica Srl via Confalonieri, 23 - 20060 - Masate - MI - Italy www.centrotecnica.net