

GEMINI 6000G2

AUTOMATIC HARDNESS TESTER | SERIES

ROCKWELL | SUPERFICIAL ROCKWELL | BRINELL

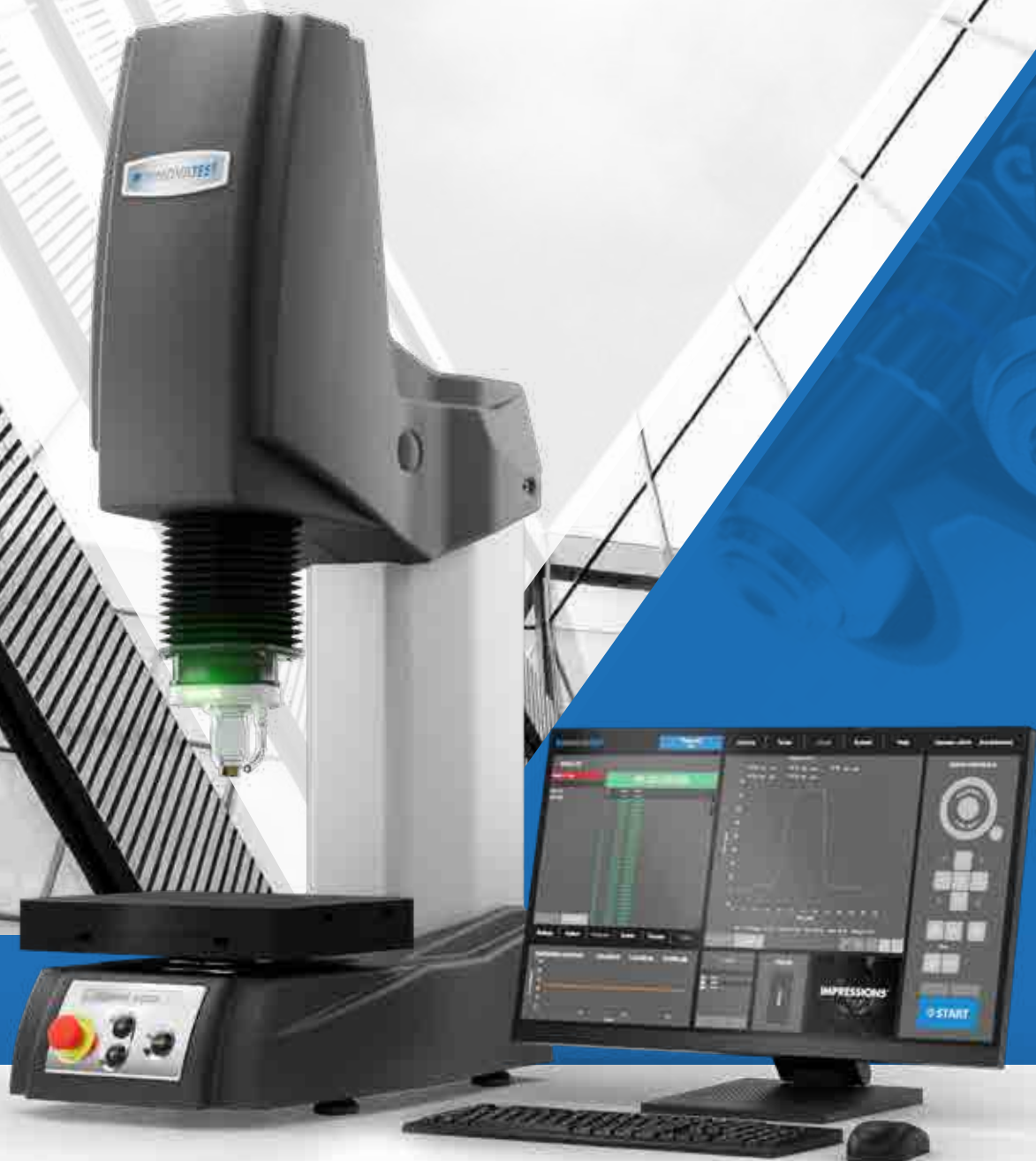

GEMINI 6000G2 SERIES

Where Innovation Meets Excellence...

The 6100 Series hardness tester is a cutting-edge instrument for precise Rockwell hardness testing. Its all-linear force application system, featuring a descending test head and fixed workpiece position, eliminates depth measurement tolerance errors for superior accuracy.

The tester is equipped with a load cell in a force-feedback, closed-loop system, driven by precision motor technology for highly accurate and repeatable testing. The I-TOUCH™ software provides full control over testing functions and USB connectivity for easy data management.

Ideal for testing aircraft engine parts, automotive components, production lines, and quality assurance, the 6100 Series comes in two versions: a short model for high-precision labs and a tall version for industrial environments handling larger parts. The integrated large test table supports various fixtures like V-anvils, ensuring flexibility for different applications.

Configure your required version & test force range

1kgf	GEMINI 6100G2 SRS	250kgf
1kgf	GEMINI 6100G2 TRS	250kgf
1kgf	GEMINI 6200G2 SRS	250kgf
1kgf	GEMINI 6200G2 TRS	250kgf

The 6200 models are high-performance hardness testers featuring a load cell, force feedback, and a closed-loop control system driven by a electronic motor technology for precise and repeatable testing. Integrated with IMPRESSIONS™ advanced software, it provides full control over testing parameters and supports accessories like Jominy fixtures and motorized stages, making it suitable for a wide range of applications.

Designed for testing aircraft engine parts, automotive components, and production line samples, the 6200 model meets the highest standards for laboratory and industrial use. Its large test table accommodates various part sizes and supports V-anvils and other fixtures. Available in two configurations: a compact version for high-end labs and a taller model for larger parts and workshop environments.

HIGHLIGHTS

- 1 Load cell, force feedback, closed loop system
- 2 IRIS™ intelligent indenter system
- 3 Clamping attachment with auto-start function
- 4 Cross laser positioning system
- 5 Multi color LED machine status indicator
- 6 Top-class replaceable body parts, ABS covers
- 7 Workpiece height: (S)150 or (T)300mm
- 8 Fast up/down & start buttons on front panel

6100G2 SERIES

- 9 iTOUCH™ user interface with 6,5" touch screen
- 10 Optional Brinell scales & manual microscope
- 11 USB connectivity
- 12 **S Model:** fixed large test table
T Model: fixed Extra Large test table

6200G2 SERIES

- 9 IMPRESSIONS™ 4 workflow control 24" touch screen
- 10 Optional Brinell scales & BIOS Brinell Scanner
- 11 LAN, WLAN, RS-323, USB connectivity
- 12 **S Model:** fixed large test table
T Model: iSMART docking station

HARDNESS SCALES

- ROCKWELL** 3kgf - 150kgf
- BRINELL** 1kgf - 250kgf
- HVD (HVT)** 5kgf - 120kgf
- HBD (HBT)** 5kgf - 250kgf
- PLASTICS** 5kgf - 98kgf
- CARBON** 7kgf - 150kgf



SUPPORTED METHODS & SCALES



TESTING WITHOUT CLAMPING

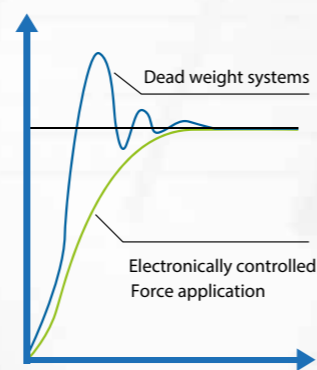

Load cell, closed loop, force feedback system

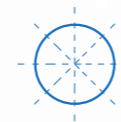

ROCKWELL

EN-ISO 6508, ASTM E-18, JIS Z 2245

Regular Rockwell scales; Pre Load 10kgf, Main Load 60kgf | 100kgf | 150kgf

A B C D E F G H K L M P R S V

Superficial Rockwell scales; Pre Load 3kgf, Main Load 15kgf | 30kgf | 45kgf

15N 30N 45N 15T 30T 45T 15W 30W 45W 15X 30X 45X 15Y 30Y 45Y



BRINELL

DIN EN ISO 6506, ASTM E-10

HBW1/1	HBW1/1.25	HBW1/2.5	HBW1/5	HBW1/10
HBW1/30	HBW1/31.25	HBW2.5/6.25	HBW2.5/7.8125	HBW2.5/15.625
HBW2.5/31.25	HBW2.5/62.5	HBW2.5/187.5	HBW5/25	HBW 5/31.25
HBW 5/62.5	HBW5/125	HBW5/250	HBW10/100	HBW10/125
HBW10/250				

PLASTICS

ISO 2039

49,03 N	132,9 N	357,9 N	961 N	HBW1/10
---------	---------	---------	-------	---------

CARBON

HR 2.5/7	HR 5/7	HR 5/15	HR 5/20	HR 5/40
HR 5/60	HR 5/100	HR 5/150	HR 10/20	HR 10/40
HR 10/60	HR 10/100	R 10/150		



CONVERSIONS

DIN EN ISO 18265, DIN EN ISO 50150, ASTM E140

REVOLUTIONIZE HARDNESS TESTING

WITH THE SMART INDENTER SYSTEM

It is easy to make failures in hardness testing, experiencing wrong readings and having hardness test results that don't match with the reality. Often and mainly this is caused by a faulty indenter. Broken indenters and worn out indenters make that hardness testers present wrong values. Indenters with expired calibration dates make test results no longer reliable or traceable.

Calibrating the tester with a broken or worn out indenter is setting a good working machine to present wrong figures. This can particularly create disaster in the aerospace and automobile industry. Testing with a wrong indenter that does not match with the hardness scale is another common problem.

But all these problems are now part of the history! Innovatest developed an indenter recognition system and electronics that establish communication between the indenter and the hardness tester, with a dialog on the user interface. We named it IRIS®. Indenter Recognition and Identification System.



IRIS™

The new GEMINI 6000 series is equipped with a sophisticated Indenter Recognition & Identification System. A Bi-directional communication system between the tester's electronics and the indenter assures you that testing with the wrong indenter is impossible and warns you of the use of indenters that have exceeded their calibration date.

The system also stores all relevant information regarding the indenter's use in the tester, including the number of indents made, the last calibration date, and other pertinent data. This is a significant enhancement for use in an ISO 17025 quality control environment and is considered essential for critical industries such as automobile and aerospace.

High force clamping attachment and indenter protection

The GEMINI series is equipped with a slim yet powerful clamp surrounding the indenter, designed for protection, versatility and performance. The clamp is fully adjustable, with replaceable jaws available in various materials to optimize performance based on the hardness of the material being tested.

This adaptability ensures precise and reliable testing across a range of materials. Additionally, the clamp can be easily removed, revealing the long and narrow indenter shaft (see page 6), which enables testing in recesses, grooves, or other hard-to-reach places.

Device status LED indicator

The status LED indicator provides a quick, visual cue of the tester's current stage in the process. By changing colors—green, blue, and red—and varying blink speeds, users can easily track the process stage, duration, and speed, particularly during any unexpected events. The LED panel is strategically positioned in the indentation area, ensuring it's clearly visible from a distance and during the indentation process itself.

Automatic workpiece height detection

Pushing the start button at any indenter position will start a rapid descent of the test head.

The automatic height detection system of the GEMINI series identifies when the indenter is near the test object and seamlessly transitions from fast descent to approach speed, in compliance with ISO/ASTM standards (when the clamp is installed). indenter shaft, which enables testing in recesses, grooves, or other hard-to-reach places.

SPECIAL FIXTURES

The GEMINI series, test tables, anvils and iSMART motorized stages provide a wide range of automation solutions.

There is a selection of special fixtures for a wide range of automated testing solutions. Fixtures for fully automatic testing of crank shafts, turbo fans or transmission parts. Steering components and suspension systems as well as parts for aerospace turbines and others.

Ask our sales department for engineered solutions.

LASER POSITIONING

LASER POSITIONING TECHNOLOGY ON BOTH 6100 & 6200

Cross laser workpiece positioning offers exceptional precision, which is essential for accurate hardness testing.

By allowing for quick and efficient alignment of objects, the laser ensures that the correct testing point is consistently targeted. This reduces the likelihood of missing the intended spot and significantly minimizes the margin for human error, resulting in more reliable and consistent test results.



DOCKING STATION

The GEMINI 6000G2 Series has a iSMART™ docking station for the quick mounting of workpiece platforms. The docking station allows a wide variety of test tables, anvils, manual XY stages and the new wireless iSMART™ motorized CNC X-Y stages to dock within seconds. In this way, the user can create the most ideal circumstances for his particular workpiece.

iSMART™ technology offers unlimited configuration freedom and safety for your tester. Creating a hardness testing system that can be configured to any requirements with standard or bespoke options, fitting a wide range of stage accessories and fixtures. Automatic Stage recognition provides overload protection and damage to accessories.

The iSMART docking station is a new INNOVATEST standard. It can be found on an increasing number of hardness testers.

This means that you can change your fixtures, stages, anvils and even the wireless iSMART™ motorized CNC X-Y stage between the various machines in your possession. No need to duplicate expensive tooling for different machines.

The iSMART™ docking station provides communication identification and power supply to various mounted accessories.



iSMART™

MOTORIZED CNC X-Y STAGES

The new wireless (or wired) iSMART™ motorized CNC X-Y stages provide excellent specifications combined with maximum flexibility. This new technology allows you to purchase a standard machine to start with, add stages, change dimensions of motorized CNC stages according to new requirements later in the life of the tester and upgrade in just seconds!

WIRELESS iSMART™ STAGES

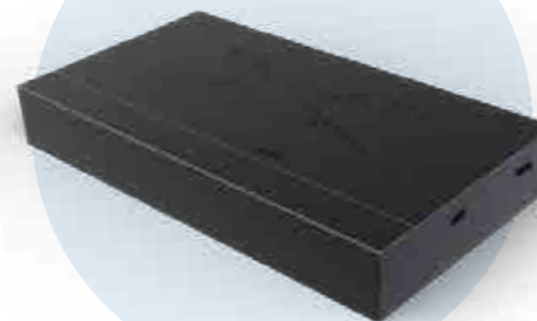

iSMART™ technology reduces possible down time on stage maintenance to seconds in case of calamities. While most automatic machines will be "out of service" if the stage is defective, a wireless iSMART™ stage can just be exchanged in seconds. No downtime!

There is a choice of 7 different type of iSMART™ stages (see table below) and if you need larger dimensions or different specifications for Custom Products, we can manufacture any possible stage to your requirements.

iSMART™ stages have onboard controllers and the EIS (electronic identification system) communicates with your hardness tester to create safety and assure no stage overload can take place.

The stages have pre-determined hole patterns on their surfaces. These patterns are in line with all INNOVATEST hardness testing stage accessories such as 1, 4, 6 or 12 position sample holders, vices and others.

AVAILABLE DIMENSIONS

Type	MA-XY7575S	MA-XY1212S	MA-XY2212S	MA-XY3412S	MA-XY2015S	MA-XY3015S	MA-XY4015S
Travel mm	75x75	120x120	220x120	340x120	200x150	300x150	400x150
Surface mm	215x160	260x205	360x205	490x224	410x265	510x265	560x265
Max load kg	400	400	400	400	4000	4000	4000

Consult with our sales department for other dimensions with short lead times.

TECHNOLOGY HIGHLIGHTS

- High speed positioning by motors and drivers for medical applications.
- Ball bearing spindles with overload protection clutches.
- Integrated ultra precise position reading electronics.
- Position accuracy 0.001mm, repeatability 0.0015mm.
- 7 different dimensions and travel options, see table above.
- Maximum load 400kg or 4000kg.
- Quick Change iSMART™ adapter, mount stage in seconds
- Wireless or wired connectivity.
- Replaceable, upgradeable, interchangeable.
- Matt black finish for maximum contrast with objective and overview camera's.

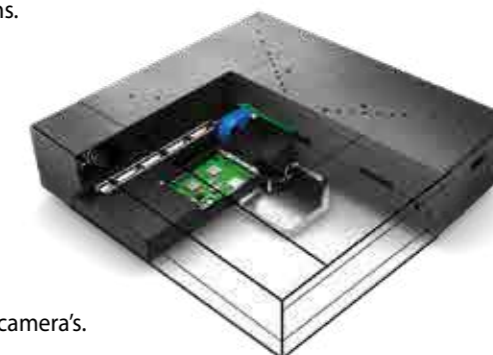

Intuitive tester and process control

The I-TOUCH™ software features intuitive multi-function keys for testing, setup, data storage, and program uploads, simplifying tester operation to the fullest.

With just a single press, users can export data, perform single or batch readings, or automate the process entirely. Results can be saved to a USB stick or transferred via cable to a PC (or Wi-Fi / Bluetooth for 6200 models) for easy import and evaluation in for instance Excel.

Advanced features include enhanced statistical analysis, shape correction for convex, concave, or spherical specimens, and hardness conversion to Rockwell, Brinell, or tensile strength in accordance with ASTM E140 and ISO 18625 standards, with support for various material tables.

The system offers a tabletop control panel with an adjustable viewing angle or an integrated version built into the tester's frame. In all configurations, the panel is securely housed in a durable aluminum frame, ensuring long-lasting, robust performance.



OPERATING COMFORT WITH I-TOUCH

INNOVATIVE SOFTWARE FUNCTIONS

MEASUREMENT OVERVIEW



OUT OF SET LIMITS



The purpose of software is to control complexity...

Software that optimizes user comfort with a wide range of standard functionality such as auto measurement, auto-focus, reporting, test program storage, and many more.

For the more advanced users, for whom the standard applications would not be sufficient, IMPRESSIONS™ 4 has an unmatched level of optional “apps” that can be installed as plugins, later, at any moment. During the purchase of your tester, decide on what you need at that moment. Widen your options at any moment by a simple e-mail and a few mouse clicks, to install optional functionality. As easy or simpler than installing an app on your mobile phone.

POWERED BY IMPRESSIONS v4

Next gen workflow & tester control...



Just buy a software release ticket, and your tester has added functionality, regardless where it is located. A revolutionary system taking care of all your needs.

In this way we keep the learning curve, the process to work efficiently with our software limited to the level of “need to have” and “need to know”. The proportion of installed and activated software never needs to be more than your requirements.

On the higher end, IMPRESSIONS 4 connects flawlessly with quality control systems such as QDAS, exports files in CVS, XML or other formats and if your requirement is not standard, our team of engineers will efficiently find ways to handle your data properly. Bespoke solutions such as connectivity to robotic systems are standard solutions for INNOVATEST™.

Unique to IMPRESSIONS™ 4 is a choice for screen size and position. Whether you wish your interface to be in portrait mode or landscape, all functionality is supported in both positions. For table top solutions like testers in laboratories, users often opt for landscape screen(s).

On the shopfloor the large landscape screens are often an unwanted component either requiring a table top or machine mounted bracket taking a lot of space and cables to deal with. IMPRESSIONS 4 leaves you the option to go for landscape or for portrait mode on a large selection of our machines.

For the GEMINI 6000G2, INNOVATEST recommends the 27” industrial quality landscape screen operated by both touch as well as mouse and keyboard. One screen is standard included with the hardness tester, optional is the Dual view function, these are 2 x 24” industrial quality landscape screens. New applications are added to IMPRESSIONS™ on a regular basis; while INNOVATEST provides 10 years free updates, upgrades to more functionality or new additions can be purchased at any time.

TIME REDUCING

SMART SOLUTIONS, SEAMLESS PERFORMANCE...

1 PATTERN EDITOR

The IMPRESSIONS™ pattern editor allows the user to create any number of test patterns with a large number of variable settings. Create test patterns with great precision and freedom. Verify the settings in the preview mode. Drag & drop patterns from one test sample to another sample. Live vision technique over zoom overview camera, no image stitching required.

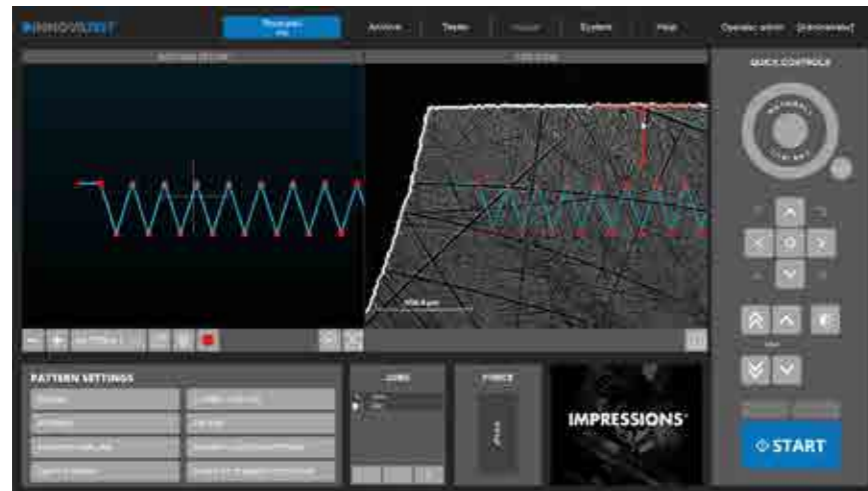

Combine different patterns and even different test forces in one program, and run them fully automatically. All test points can be identified individually or to customer specifications. The label is shown in the test result list and in the test results overview and in the results print out. An important function for sample analyses at the end of a test and in the future for review of previous tests.

2 SNAPSHOT FUNCTION

This handy function in IMPRESSIONS™ allows you to make screen captures of the viewing area by way of objective view and/or Overview camera. It gives the opportunity to store such images with comments or to paste them into the report generator for further processing.



3 USER DEFINED PROGRAMS

For repeating jobs, IMPRESSIONS™ utilizes the option of setting up and storing custom test programs. For each task, a "job" can be created. All application specific parameters, such as hardness scale, force, dwell-time, pattern, conversion and the report template are stored in the same program.

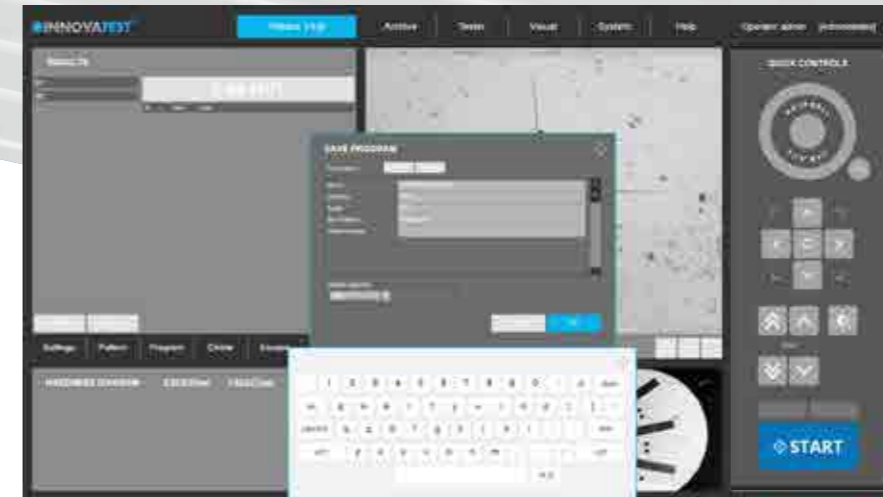

4 REPORT GENERATOR

Imagine having a report created for you that includes: Your company name, address, contact information, labeled results related to patterns or sequential, pictures of your optical measurements, stitched images, notes section for each result or pictures, rendition of the pattern performed, overview picture of your pattern on your sample, full statistics, summary of your results, go no-go results, Pass or fail...

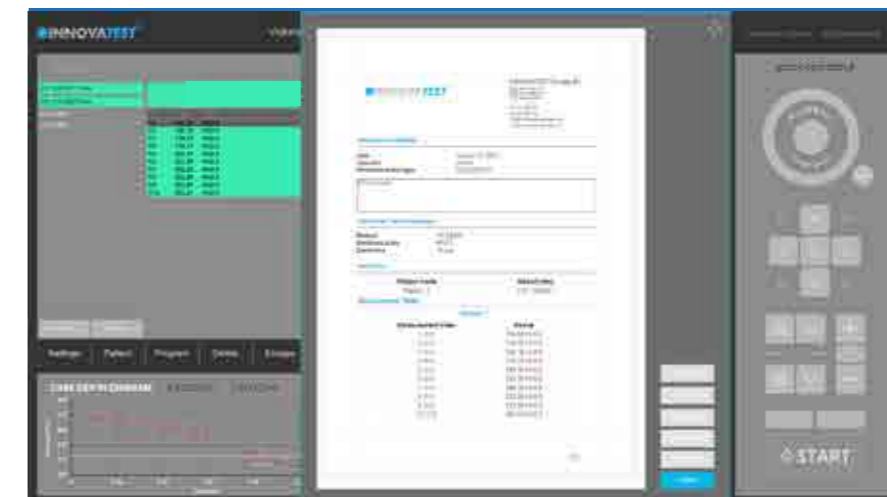

All this information or having the ability to only have what you need reported, we call this our Report Configurator. You decide how much or how little you report by PDF or laser printer. We even keep it simple by choosing export to CSV file, to a thumb drive or network file location. Data management at its best!

VARIOUS SCENARIOS

While the 6100 series have large integrated testing tables with a specific adapter to use all kinds of special anvils as well (V-anvils, flat anvils etc.) the 6200 series is equipped with the iSMART adapter that allows any kind of manual or motorized X-Y stage to be installed.

Larger parts fit directly at the standard installed oversized testing tables without the need to purchase special tables or larger anvils.

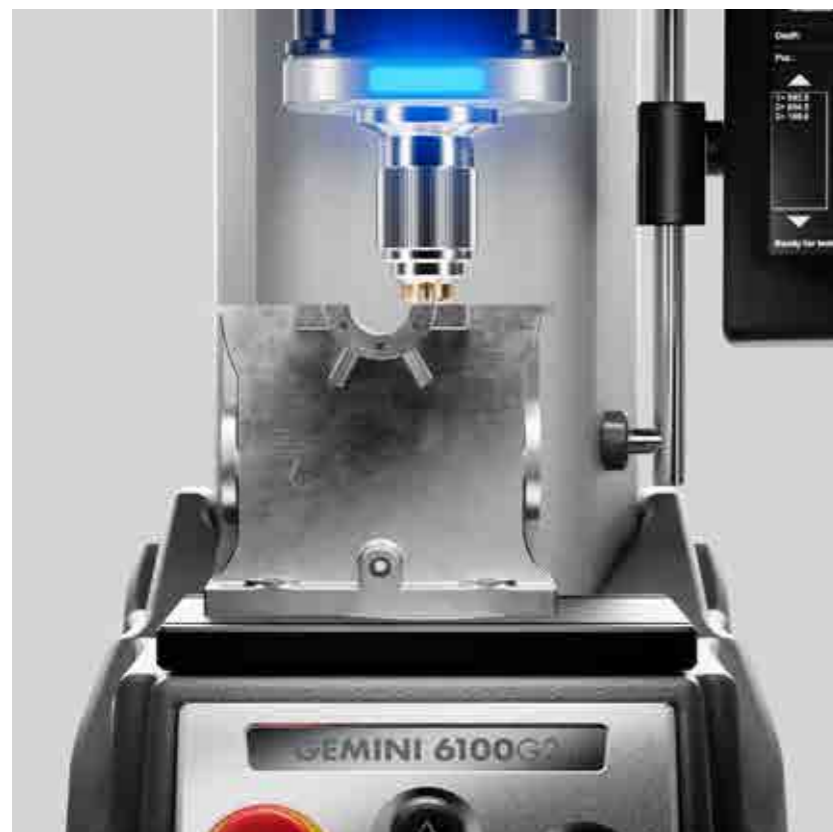
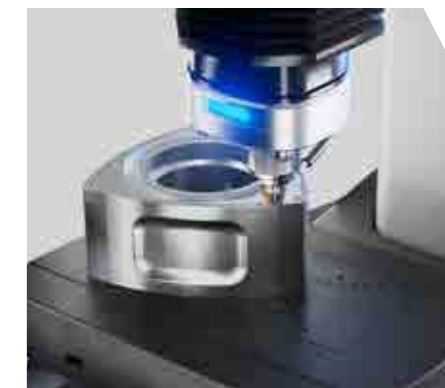



STEP 1: Select machine type



STEP 2: Hardness Scales

Select preferred hardness scales

STEP 3: Clamping

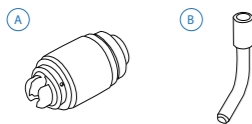

STEP 4: Indenters

1 Indenters

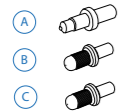

STEP 5: Optical

2 Overview Camera

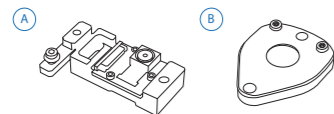

4 Optical Scanners

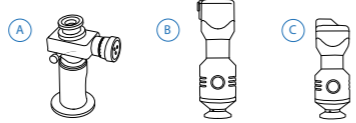

STEP 6: Stages/Anvils

5 Stages

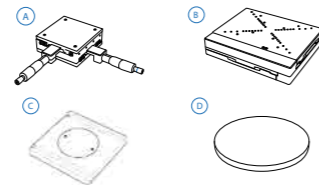

6 Anvils

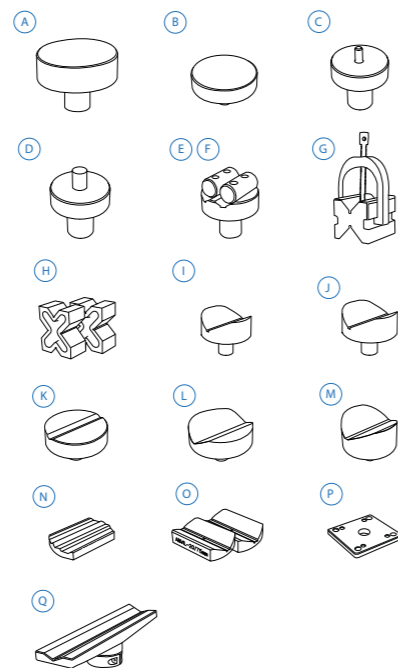

STEP 7: Fixtures & Vices

7 Fixtures & Vices

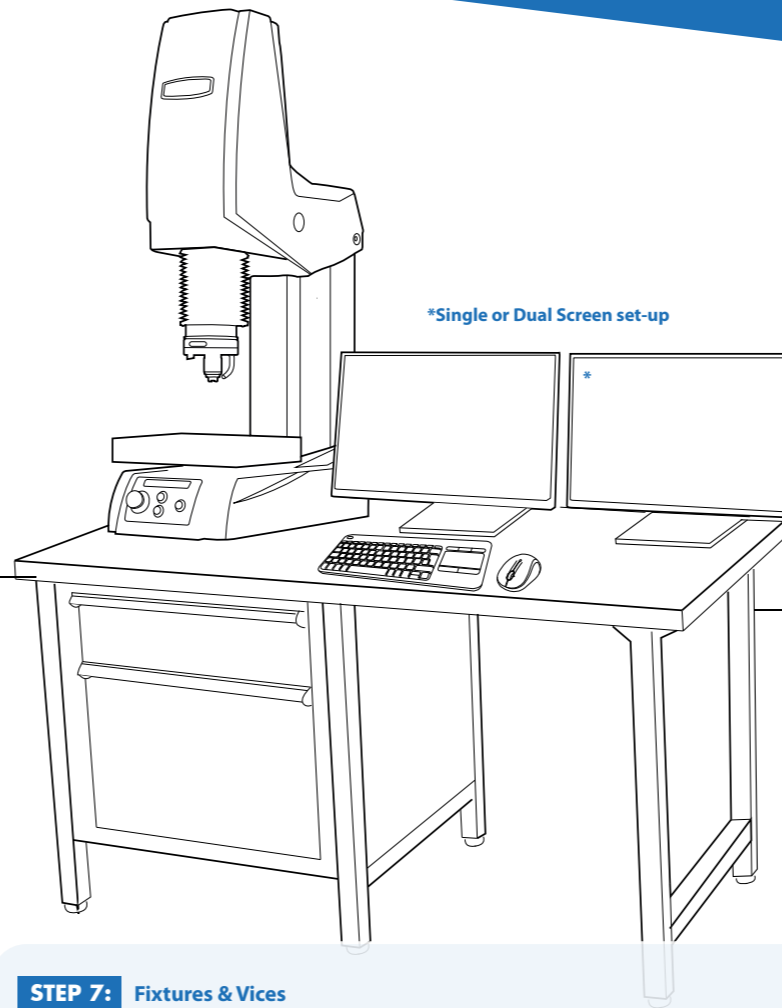
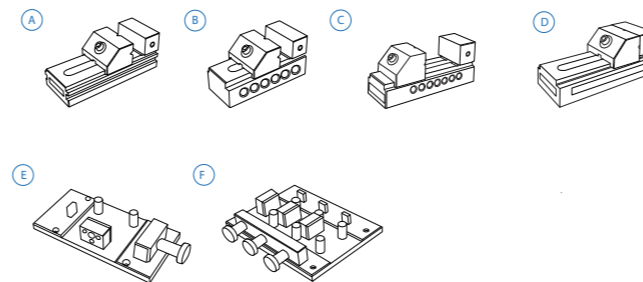

STEP 8: Software



✓ = Standard included

ORDER DETAILS

GEMINI 6000G2



GEMINI 6100 SRS, Rockwell hardness tester, iTOUCH Control, Short frame	GEMINI 6100 SRS	
GEMINI 6100 TRS, Rockwell hardness tester, iTOUCH Control, Tall frame	GEMINI 6100 TRS	
GEMINI 6200 SRS, Rockwell hardness tester, IMPRESSIONS™ 4 Control, Small frame	GEMINI 6200 SRS	
GEMINI 6200 TRS, Rockwell hardness tester, IMPRESSIONS™ 4 Control, Tall frame	GEMINI 6200 TRS	
Plug & Play prepared, calibration, sea & airworthy packing in "non coniferous wood" material.	P&PSEAPACK100	SRS MODEL
Plug & Play prepared, calibration, sea & airworthy packing in "non coniferous wood" material.	P&PSEAPACK101	TRS MODEL

ACCESSORIES

STEP 2	Hardness scales			
	A	Rockwell scales 10-150kgf	RKWSCL	
	B	Superficial Rockwell scales 3-45kgf	SRKWSCL	
	C	Rockwell/Superficial Rockwell scales 3-150kgf	TRKWSCL	
	D	Brinell scales 1kgf - 250kgf	BRINSCL	
	E	HVD & HBD depth measuring scales V 5-120, B 5-250kgf	HVTHBTSCL	
	F	Scales for plastic 49N - 961N	ISO2039SCL	
	G	Carbon scales HR 2.5/7 - HR 10/150	CARBSCCL	
	H	Rockwell, Super Rockwell, Brinell, HVD, HBD, Plastic, Carbon	ALLSCL	
STEP 3	Clamping	A Workpiece Clamp with auto start function	SA-02-0148	
		B Workpiece illumination LED - removable	SA-05-0074	
STEP 4	Indenters			
1	Rockwell	A Rockwell C Diamond iSMART Indenter, ISO & ASTM certified	UPI/6005S	
		Rockwell Ball iSMART Indenter 1/16". Includes 1 carbide ball, ISO & ASTM certified	UPI/7506S	
		Rockwell Ball iSMART Indenter 1/8". Includes 1 carbide ball, ISO & ASTM certified	UPI/7606S	
		Rockwell Ball iSMART Indenter 1/4". Includes 1 carbide ball, ISO & ASTM certified	UPI/7706S	
		Rockwell Ball iSMART Indenter 1/2". Includes 1 carbide ball, ISO & ASTM certified	UPI/7806S	
	Brinell	B Brinell iSMART Indenter 1mm. Includes 1 carbide ball. Ø6.35mm. ISO & ASTM certified	UPI/7000S	
		Brinell iSMART Indenter 2.5mm. Includes 1 carbide ball. Ø6.35mm. ISO & ASTM certified	UPI/7005S	
		Brinell iSMART Indenter 5mm. Includes 1 carbide ball. Ø6.35mm. ISO & ASTM certified	UPI/7010S	
		Brinell iSMART Indenter 10mm. Includes 1 carbide ball. Ø6.35mm. ISO & ASTM certified	UPI/7015S	
	Vickers	Macro iSMART Vickers Indenter Ø6.35mm, ISO & ASTM certified	UPI/8010S	
STEP 5	Optical			
2	Overview Camera	A Overview / Full view zoom camera + software functionality, includes crosslaser	SA-70-0023	6200G2 TRS
		B Cross Laser	SA-05-0075	6200G2
3	Optical Scanners	A Analogue Brinell indent measuring microscope 20x	ASS3001-MICRO/01	
		Analogue Brinell indent measuring microscope 40x	ASS3001-MICRO/02	
		B 5mpx USB3 Brinell Indent Optical Scanner for indents from 1.2 to 6mm (most common) made with 5mm or 10mm ball indenter	SA-12-0001	6200G2
		C 5mpx USB3 Brinell Indent Optical Scanner for indents from 0.24 to 1.5mm made with 1 mm or 2.5 mm ball indenter	SA-12-0002	6200G2
STEP 6	Stages/Anvils			
5	Stages	A Manual X-Y stage with analogue metric micrometers, 180x160mm Displacement: 25x25mm, scale 0.01mm, max load 300kg	UN-TESTTABLE/030	TRS MODEL

		B iSMART™ stage, 215x160mm, total load up to 400kgf max. Displacement: 75x75mm, resolution 0.001mm, repeatability +/-0.0015mm	MA-XY7575S	
		iSMART™ stage, 215x160mm, total load up to 400kgf max. Displacement: 75x75mm, resolution 0.001mm, repeatability +/-0.0015mm	MA-XY1212S	
		iSMART™ stage, 260x205mm, total load up to 400kgf max. Displacement: 120X120mm, resolution 0.001mm, repeatability +/-0.0015mm	MA-XY2212S	
		iSMART™ stage, 360x205mm, total load up to 400kgf max. Displacement: 220X110mm, resolution 0.001mm, repeatability +/-0.0015mm	MA-XY3412S	
		iSMART™ stage, 490x224mm, total load up to 400kgf max. Displacement: 340X120mm, resolution 0.001mm, repeatability +/-0.0015mm	MA-XY2015S	
		iSMART™ stage, 410x265mm, total load up to 400kgf max. Displacement: 200X150mm, resolution 0.001mm, repeatability +/-0.0015mm	MA-XY3015S	
		iSMART™ stage, 510x265mm, total load up to 400kgf max. Displacement: 300X150mm, resolution 0.001mm, repeatability +/-0.0015mm	MA-XY4015S	
5	<i>Cable sets, mounting & connectivity for motorized stage</i>	iSMART docking station	SA-08-0027	6200G2 TRS
	Test Tables	C Flat table 210mm x 160mm	SA-08-0030	STANDARD SRS MODEL
		Flat table 300mm x 250mm	SA-08-0031	STANDARD TRS MODEL
		D Testing table flat ø200mm, screwfix	UN-TESTTABLE/010	TRS MODEL
		Testing table flat ø235mm, screwfix	UN-TESTTABLE/012	TRS MODEL
		Flat table 160mm x 160mm	CM-08-0353	SRS MODEL
6	Anvils	A Flat anvil 60mm	AS3000-19-04	
		B Flat anvil 80mm	UN-TESTTABLE/002	
		C Spot anvil 5mm	UN-ANVIL/010	
		D Spot anvil 10mm	UN-ANVIL/011	
		E V block with bracket 40x40x50mm (LxBxH)	UN-VBLOCK404050	
		F Steel, cross type, (X) V-block 60x120x100mm 8-90mm pair	UN-CROSSBLOCK01	
		G V-anvil ø40mm 6-60mm	UN-ANVIL/005	
		H V-anvil ø63mm 10-100mm	UN-ANVIL/006	
		I V-Anvil ø80mm 3.3-20mm	UN-ANVIL/040	
		J V-Anvil ø80mm 15-80mm	UN-ANVIL/045	
		K V-Anvil ø80mm 23-40mm	UN-ANVIL/050	
		L Anvil for round specimen dia. 6-25,4mm	UN-ANVIL/200	
		M Cylindrical V anvil 6-80mm	UN-CVANVIL680	
		Cylindrical V anvil 50-200mm	UN-CVANVIL50200	
		Test table 100x100mm, V groove 20mm wide, 10mm deep	UN-TESTTABLE/040	
		N Small V-Anvil 3-20mm requires base plate (Requires Manual/Autom. X-Y stage)	UN-ANVILSV/105	TRS MODEL
		O Large V-Anvil 20-75mm requires base plate (Requires Manual/Autom. X-Y stage)	UN-ANVILLV/106	TRS MODEL
		P Base plate for V-anvils un-anvilsv/105 & 106	UN-VANVILBASEPL	TRS MODEL
		O Extra long v-anvil (Ø10 - Ø100)	CM-08-0186	TRS MODEL
	<i>Clamping, Locking & Fixing Adapters</i>	Quick change anvil base (required for mounting testing tables, anvils)	AS5000-450	TRS MODEL
		Accessories disc (Ø 85)*	CM-08-0352	
		Dove tail mounting plate	CM-08-0033	TRS MODEL
		Lock flange	UN-XYZ BUSH50	TRS MODEL
		Mounting plate for lock flange	UN-XYZ30FP50-55	TRS MODEL

STEP 7	Fixtures & Vices				
7	Fixtures & Vices	Polished precision vice with lock down system, jaw width 25mm, opens 20mm	UN-VICE/210		
		Polished precision vice with lock down system, jaw width 36mm, opens 42mm	UN-VICE/215		
		Polished precision vice with lock down system, jaw width 48mm, opens 75mm	UN-VICE/220		
		Polished precision vice with lock down system, jaw width 75mm, opens 100mm	UN-VICE/230		
		JOMINY Fixture, for 1 quench end test sample, quick release function	UN-JOMFIX1	6200G2 TRS	
		JOMINY Fixture, for 3 quench end test sample, quick release function	UN-JOMFIX3	6200G2 TRS	
STEP 8	Software				
8	Additional Software	Report configurator	UN-REPORTA	STANDARD 6200G2	
		Snapshot function	UN-SNAPSH	STANDARD 6200G2	
		Advanced 3 axis coordinate & free style indent pattern configurator, for motorized stage only	UN-TESTPAT01	6200G2 TRS	
		Advanced 3 axis coordinate & free style indent pattern configurator, + CHD, SHD, NHD and edge detection, (supports manual & digital micrometer stages only)	UN-TESTPAT02	6200G2 TRS	
		Force depth/time diagram	UN-FDDIAGR	6200G2	
		User level management	UN-LEVMAN	STANDARD 6200G2	
		Q-DAS Certified connectivity protocol	UN-QDAS	6200G2	
		Advanced 3-axis communication protocol for robotic systems	UN-REMC	6200G2	
		Artificial Intelligence Deep Learning Brinell module	UN-AIDLBO1	6200G2	
		Barcode & QR data mapping software	UN-SCANFLOW	6200G2	
		Virtual Joystick, on screen		STANDARD 6200G2	
		Connectivity Plus	Powerfull External Intell Core i9 PC, with 16gb RAM, and 512gb SSD drive (or better) Windows 10 pre-installed, IMPRESSIONS™ tester work flow software IN-NOVATEST recommends Embedded Industrial computers with DeepFreeze enabled.	UN-SYSPCIMP01	6200G2
			Powerfull external intel core i9 pc, with 16gb ram, and 512gb ssd drive Windows 10 pre-installed including wiring and integration with tester.	UN-SYSPCIMP02	6200G2
			Application of customer supplied PC, plus wiring and integration with tester	UN-SYSPCIMP03	6200G2
			Bluetooth connectivity	UN-BTADAPT	6200G2
			Utility software; Import test results in MS applications like Excel	UN-SW/905	6200G2
			USB to USB null modem cable 2.5M	BE-99-0025	6200G2
			Wireless system Keyboard & wireless mouse	UN-SKBSET	6200G2
			Cabinet test table with drawer for hardness testers 150x75x80cm	UN-STAND/965	
			Seaworthy packing box for 950/960	PACK/100	
	Seaworthy packing box for 965	PACK/200			
Vibration Isolation Stage	Passive vibration isolation stage, broad spectrum	UN-AVS-150	SRS MODEL		
	Passive vibration isolation stage, broad spectrum	UN-AVS-300	TRS MODEL		
Printer	Laser Printer	UN-PRINT	6200G2		
Projector	On request, any brand of choice	UN-PROJECTOR	6200G2		
ISO/ASTM Verification	BRINELL direct and indirect verification/calibration & certification in compliance with ISO & ASTM, NADCAP. Includes direct force and indirect verification report (block readings), GR & R report, flat fee for selected common scales, per scale.	DID17025CERT B			
	ROCKWELL direct and indirect verification/calibration & certification in compliance with ISO & ASTM, NADCAP. Includes direct force and indirect verification report (block readings), GR & R report, flat fee for selected common scales, per scale.	DID17025CERT R			
	VICKERS direct and indirect verification/calibration & certification in compliance with ISO & ASTM, NADCAP. Includes direct force and indirect verification report (block readings), GR & R report, flat fee for selected common scales, per scale.	DID17025CERT V			
Cover	Machine cover 600x700x1000mm	UN-COVER5	SRS MODEL		
	Machine cover 800x800x1450mm	UN-COVER7	TRS MODEL		

ACCESSORIES

CLAMPING

Clamp Nose

A



SA-02-0148

Lighting

B



SA-05-0074

INDENTERS

A



Rockwell C Diamond iSMART Indenter, ISO & ASTM certified

B



Rockwell Ball iSMART Indenter 1/16", ISO & ASTM certified

C



Rockwell Ball iSMART Indenter 1/8", ISO & ASTM certified

D



Rockwell Ball iSMART Indenter 1/4", ISO & ASTM certified

E



Rockwell Ball iSMART Indenter 1/2", ISO & ASTM certified

F



Brinell iSMART Indenter 1mm Ø6.35mm, ISO & ASTM certified

G



Brinell iSMART Indenter 2.5mm Ø6.35mm, ISO & ASTM certified

H



Brinell iSMART Indenter 5mm Ø6.35mm, ISO & ASTM certified

I

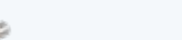

Brinell iSMART Indenter 10mm Ø6.35mm, ISO & ASTM certified

OPTICAL

Overview camera

A



SA-70-0023

B



SA-05-0075

Optical Scanners

A



AS3001-MICRO/01
AS3001-MICRO/02

B



SA-12-0001

C

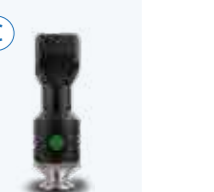

SA-12-0002

STAGES/ANVILS

Stages

A



UN-TESTTABLE/030

B



iSMART™ stages
MA-XY7575S
MA-XY2015S
MA-XY1212S
MA-XY2212S

C



UN-TESTTABLE/010
UN-TESTTABLE/012
CM-08-0353

D



UN-TESTTABLE/010
UN-TESTTABLE/012
CM-08-0353

ANVILS

Anvils



FIXTURES & VICES

Fixtures & vices



ADDITIONAL ITEMS

Machine stands



Vibration isolation stage



COVERS



SPECIFICATIONS

HARDNESS SCALES

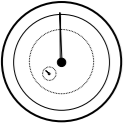
	ROCKWELL EN-ISO 6508 ASTM E18 JIS Z 2245	Regular Rockwell scales; Pre Load 10kgf, Main Load 60kgf 100kgf 150kgf A B C D E F G H K L M P R S V Superficial Rockwell scales; Pre Load 3kgf, Main Load 15kgf 30kgf 45kgf 15N 30N 45N 15T 30T 45T 15W 30W 45W 15X 30X 45X 15Y 30Y 45Y
	BRINELL EN-ISO 6506 ASTM E10 JIS Z 2243	HBW1/1 HBW1/1.25 HBW1/2.5 HBW1/5 HBW1/10 HBW1/30 HBW2.5/6.25 HBW2.5/7.8125 HBW2.5/15.625 HBW2.5/31.25 HBW2.5/62.5 HBW2.5/187.5 HBW5/25 HBW5/31.25 HBW5/62.5 HBW5/125 HBW5/250 HBW10/100 HBW10/125 HBW10/250
	HVD (HVT)	HV5 HV10 HV20 HV30 HV50 HV100 HV120
	HBD (HBT)	HB1/5 HB1/10 HB1/30 HB2.5/6.25 HB2.5/15.625 HB2.5/31.25 HB2.5/62.5 HB2.5/187.5 HB5/25 HB5/125 HB5/250 HB10/100
	PLASTIC ISO 2039	49,03 N, 132,9 N, 357,9 N, 961 N
	CARBON	HR 2.5/7 HR 5/7 HR 5/15 HR 5/20 HR 5/40 HR 5/60 HR 5/100 HR 5/150 HR 10/20 HR 10/40 HR 10/60 HR 10/100 HR 10/150
	CONVERSIONS	Conversion to other hardness scales according to ASTM E140, ISO 18265, GB/T 1172

TEST FORCE

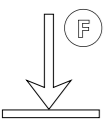
	Force application	Load cell, force feedback, closed loop system, fully automatic										
	Test forces	Pre Load : 3kgf & 10kgf. Main Load : 15kgf, 30kgf, 45kgf, 60kgf, 100kgf & 150kgf										
	Force range per model	<table border="0"> <tr> <td>GEMINI 6100G2 SRS</td> <td>1kgf – 250kgf</td> </tr> <tr> <td>GEMINI 6100G2 TRS</td> <td>1kgf – 250kgf</td> </tr> <tr> <td colspan="2"> </td> </tr> <tr> <td>GEMINI 6200G2 SRS</td> <td>1kgf – 250kgf</td> </tr> <tr> <td>GEMINI 6200G2 TRS</td> <td>1kgf – 250kgf</td> </tr> </table>	GEMINI 6100G2 SRS	1kgf – 250kgf	GEMINI 6100G2 TRS	1kgf – 250kgf			GEMINI 6200G2 SRS	1kgf – 250kgf	GEMINI 6200G2 TRS	1kgf – 250kgf
	GEMINI 6100G2 SRS	1kgf – 250kgf										
	GEMINI 6100G2 TRS	1kgf – 250kgf										
GEMINI 6200G2 SRS	1kgf – 250kgf											
GEMINI 6200G2 TRS	1kgf – 250kgf											
Test force tolerance	<0.5% <0.05% for LAB model											
Depth reading	<0.1µm <0.05µm for LAB model											

SYSTEM

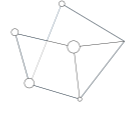
	Electronic system	High performance embedded micro system controller, MS Windows®, 24" full color capacitive touchscreen, automatic and manual measurement.
	CNC Support	5 Axis CNC controller (for motorized stages) or stage accessories
	Screen(s)	24" landscape mode capacitive touch screen, second screen option/ I-TOUCH™
	Display resolution	Selectable 0.1 or 0.01HR, 0.5HB, others 0.1
	Statistics	Total test, max, min, average, range, standard deviation, All in real time after each test
	Hardness conversion	Rockwell, Rockwell Superficial, Vickers, Brinell, Knoop, Leeb & Tensile
	Software	IMPRESSIONS™ tester and work flow control. Advanced software features including pattern testing on complex parts and X-Y stage control.
	Data storage capacity	Internal and external mSSD, SSD or HDD
	Data output	XML, CSV, Certified for Q-DAS (Optional)
	Printer	A4, A3 full color laser printer (optional)

GENERAL

	Machine dimension	GEMINI 6100G2 SRS: 915mm (H) x 310mm (W) x 510mm (D) GEMINI 6100G2 TRS: 1215mm (H) x 380mm (W) x 665mm (D) GEMINI 6200G2 SRS: 915mm (H) x 310mm (W) x 510mm (D) GEMINI 6200G2 TRS: 1215mm (H) x 380mm (W) x 665mm (D)
	Machine weight	GEMINI 6100G2 SRS:100kg GEMINI 6100G2 TRS:140kg GEMINI 6200G2 SRS:100kg GEMINI 6200G2 TRS:140kg
	Workpiece accommodation	GEMINI 6100G2 SRS: 150mm (H) x 125mm (D) GEMINI 6100G2 TRS: 300mm (H) x 225mm (D) GEMINI 6200G2 SRS: 150mm (H) x 125mm (D) GEMINI 6200G2 TRS: 300mm (H) x 225mm (D)
	Power supply	100VAC to 240VAC, 50/60Hz, single phase
	Operating temperature	10°C to 35°C
	Power consumption	100W
	Humidity	10% to 90%, non-condensing
	Noise emission	< 70 db(A)

TECHNICAL DRAWINGS

GEMINI 6100G2 SRS

All dimensions in these drawings are in mm, approximate. Working heights and or workpiece accommodation varies depending on the stages and stage accessories used.

Please contact our sales department for more details.

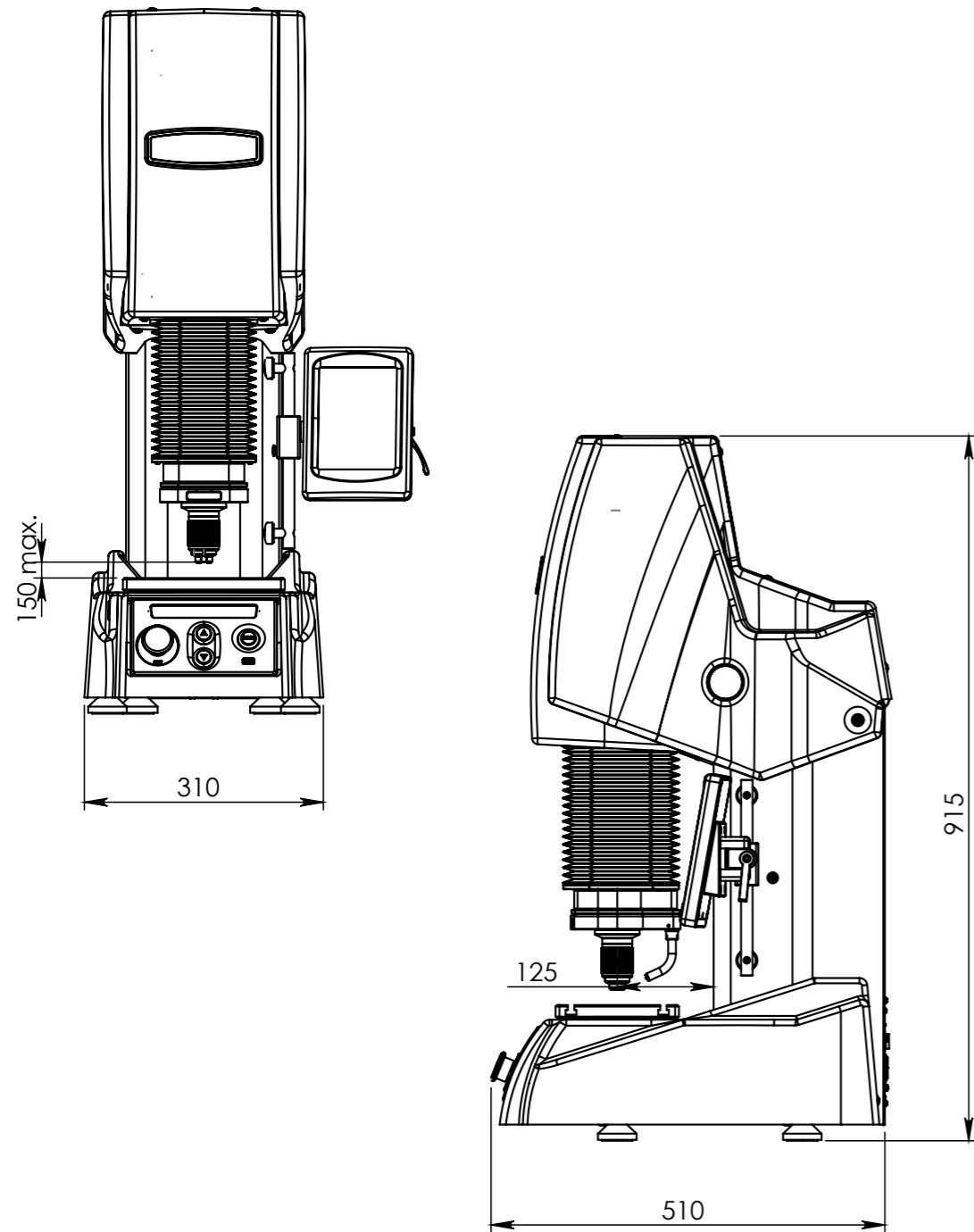

GEMINI 6100G2 TRS

All dimensions in these drawings are in mm, approximate. Working heights and or workpiece accommodation varies depending on the stages and stage accessories used.

Please contact our sales department for more details.

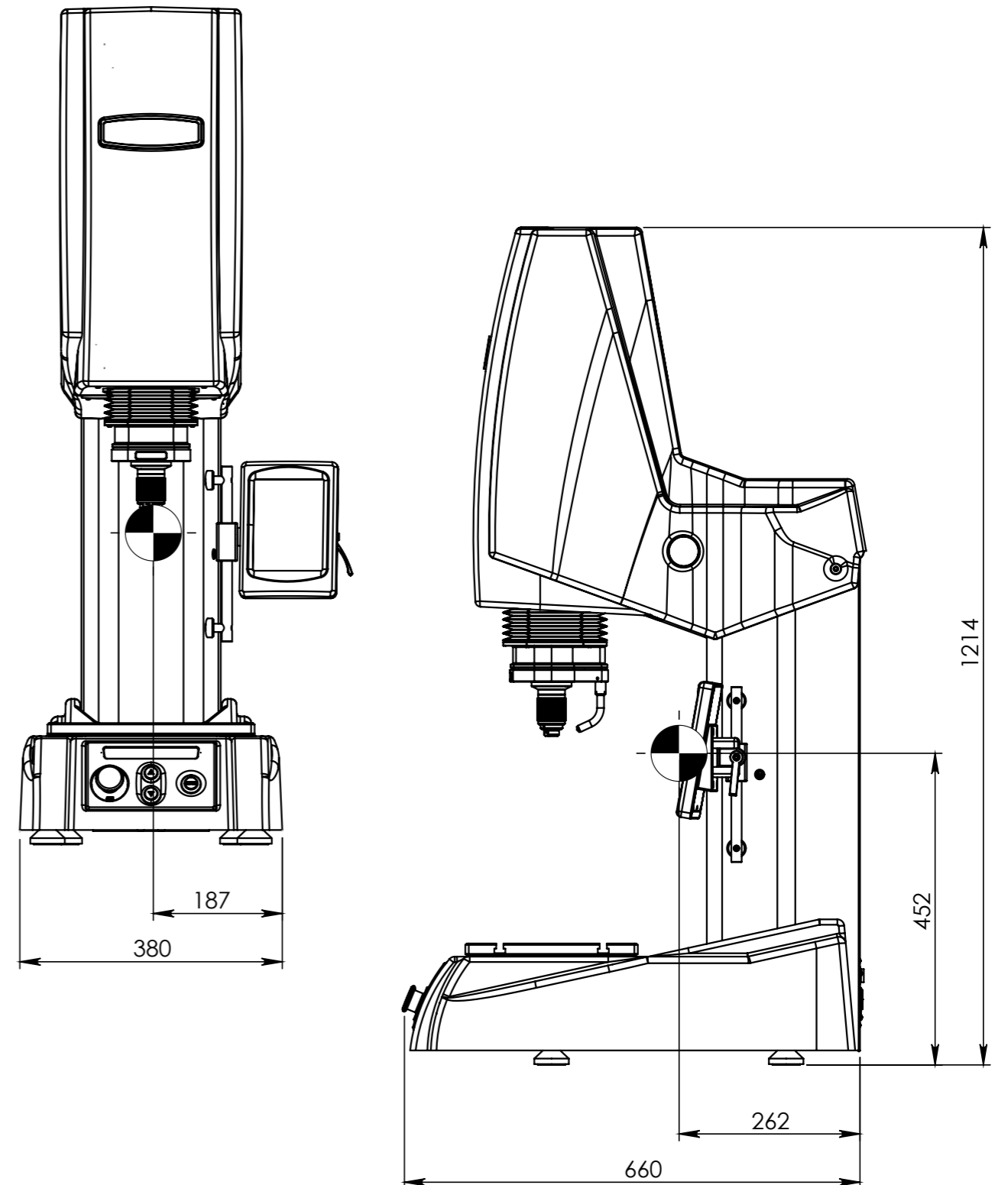

GEMINI 6200G2 SRS

All dimensions in these drawings are in mm, approximate. Working heights and or workpiece accommodation varies depending on the stages and stage accessories used.

Please contact our sales department for more details.

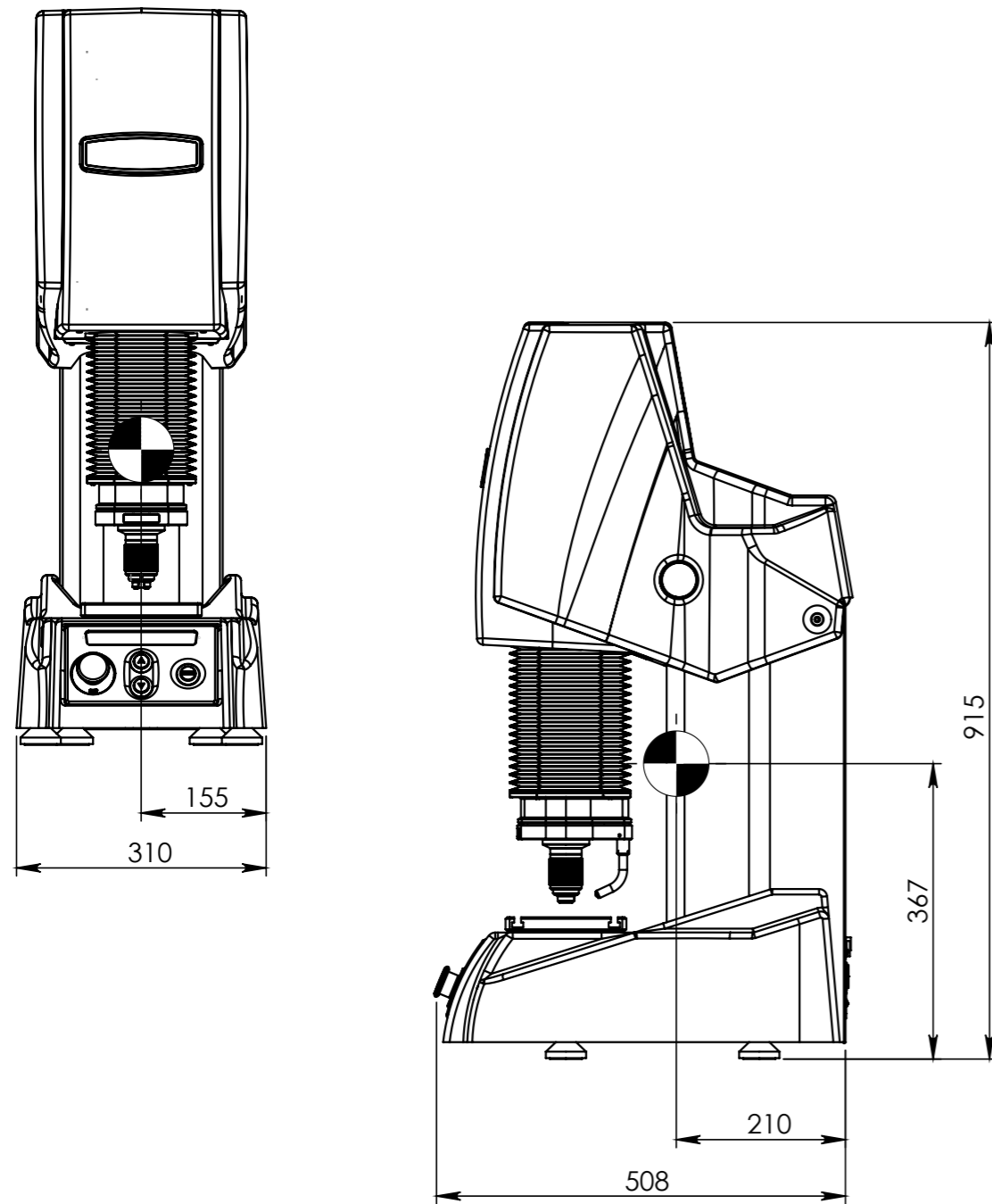

GEMINI 6200G2 TRS

All dimensions in these drawings are in mm, approximate. Working heights and or workpiece accommodation varies depending on the stages and stage accessories used.

Please contact our sales department for more details.

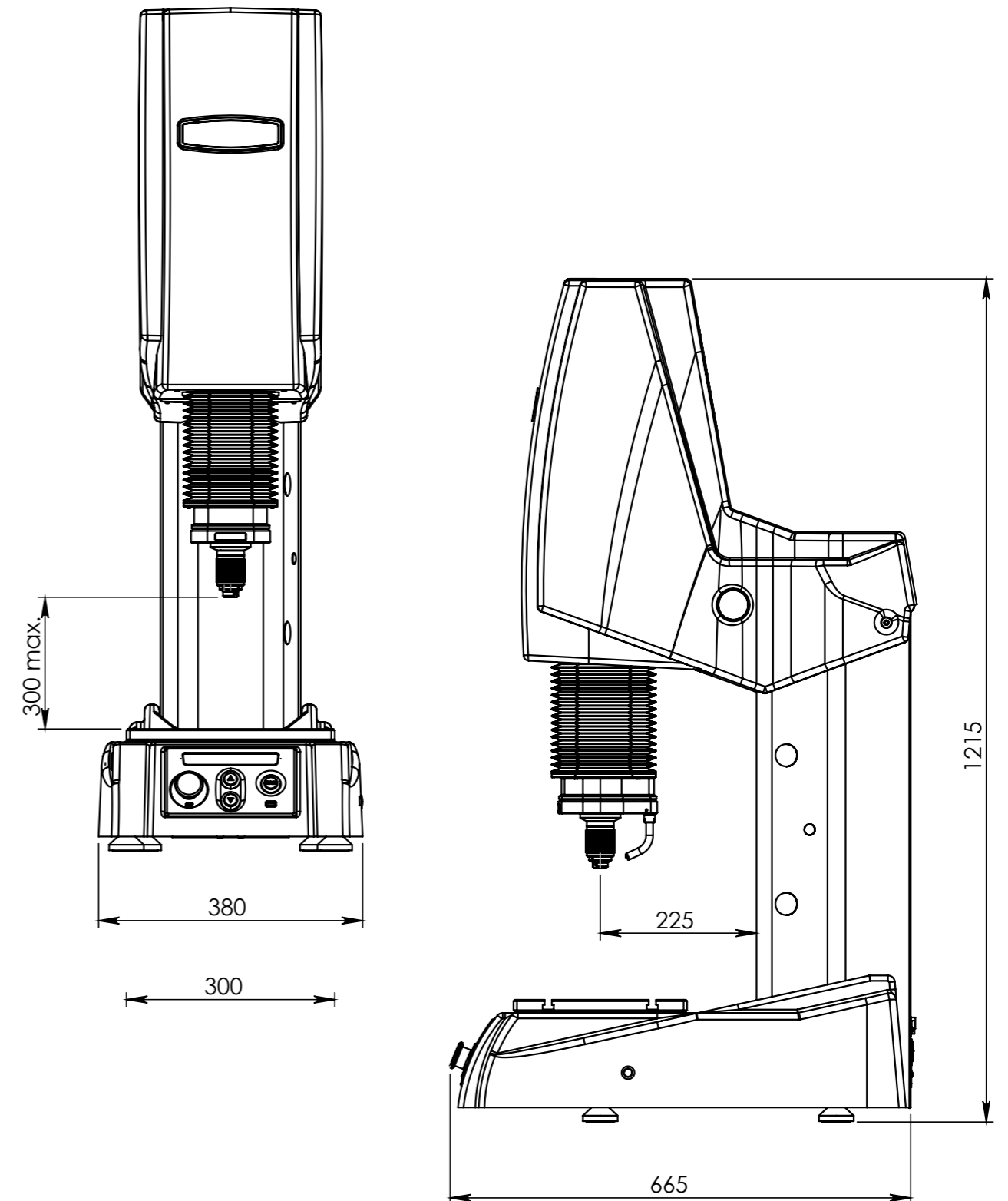

OTHER MODELS WITH ROCKWELL SCALES



FENIX 200DCL

Load Cell, closed loop, force feedback, test force application system Rockwell / Brinell hardness tester.
See brochure B18F200DCL/XX



FENIX 300RS

Load Cell, Closed loop, force feedback, test force application system Rockwell / Brinell Hardness tester with I-TOUCH™ system.
See brochure B20F300/XX



VERZUS 720

Load Cell, Closed loop Rockwell/Super Rockwell/ Brinell Hardness tester, with direct depth measuring system, integrated PC, Windows 10, WiFi, full color touchscreen.
See brochure B19V720/XX



NEXUS 3300FA

Fully automatic, Load Cell, closed loop Brinell Hardness tester. With motorized fine adjustable Z-axis.
See brochure B19N3300-3400FA/XX



NEXUS 8100RS(B)

Heavy duty fully automatic, load cell, closed loop, force feedback universal hardness tester with full HD optical zoom stage overview camera, IMPRESSIONS™ 15" full color touchscreen.
See brochure B19N8100/XX



HAWK 250RS/400RS Nose type hardness tester

Load Cell, Closed loop Rockwell/Superficial Rockwell hardness tester, with direct depth measuring system, Graphic User Interface, 6.5" Full color touchscreen.
See brochure B20HSERIES/XX



HAWK 652RS-IMP Nose type hardness tester

Load Cell, Closed loop, Fully automatic Rockwell/ Superficial Rockwell hardness tester with dual motorized Z-Axis, IMPRESSIONS™ software, 15" industrial capacitive touchscreen.
See brochure B20HSERIES/XX

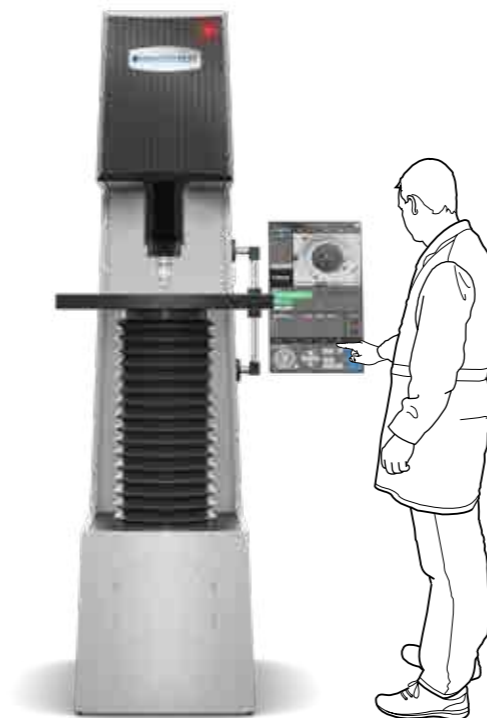

NEMESIS 9600G2 RS(B)

Load Cell, closed loop Brinell, Rockwell, Superficial Rockwell Hardness tester With motorized Z-axis & BIOS Brinell Indent Optical Scanner
See brochure B19N9600/XX

Changes in products and/or product specifications can emerge due to new technologies and continuous development.

We reserve the right to change or modify specifications of the products without prior notice. We recommend you to contact our sales office for up-to-date information.

Brochure B24G6000G2/02/EN

EUROPE

INNOVATEST Deutschland GmbH.
Sales & Service
Phone: +49 245 670 59 500
info@innovatest-deutschland.com
www.innovatest-deutschland.com

INNOVATEST France SARL
Sales & Service
Phone: +33 1 848 88038
commercial@innovatest-france.com
www.innovatest-france.com

INNOVATEST UK Ltd.
Sales & Service
Phone: +44 (0) 121 824 4775
info@innovatest-uk.com
www.innovatest-uk.com

INNOVATEST Polska sp. z o.o
Sales & Service
Phone: +48 697 099 826
info@innovatest-polska.pl
www.innovatest-poland.com

MIDDLE EAST

INNOVATEST Middle East LLC
Sales & Service
Phone: +971- 4- 880 0875
info@innovatest-mideast.com
www.innovatest-mideast.com

NORTH-AMERICA

INNOVATEST USA Inc.
Sales & Service
Phone: +1 267 317 4300
info@innovatest-usa.com
www.innovatest-usa.com

ASIA

INNOVATEST Shanghai Co., Ltd.
Sales & Service
Phone: +86 21 60906200
Fax: +86 21 60912595
info@innovatest-shanghai.com
www.innovatest-shanghai.com

INNOVATEST Japan K.K.
Sales & Service
Phone: +81 3 6667 0554
Fax: +81 3 6667 0556
info@innovatest-japan.com
www.innovatest-japan.com

INNOVATEST South East Asia
Sales & Service
Phone: +65 6451 1123
Fax: +65 6452 1011
info@innovatest-singapore.com
www.innovatest-singapore.com

Distributor :

CORPORATE HEAD OFFICE

INNOVATEST Europe BV
Manufacturing, Distribution & Service
Borgharenweg 140
6222 AA MAASTRICHT
The Netherlands

Phone: +31 43 3520060
Fax: +31 43 3631168
info@innovatest-europe.com
www.innovatest-europe.com